

USER GUIDE

Spectra Precision Ranger 7

Data Collector

Version 1.00
Revision B
August 2018



Corporate Office

Trimble Inc.
935 Stewart Drive
Sunnyvale, CA 94085
USA
www.trimble.com

Global technical support

To request detailed technical assistance for Trimble solutions, contact: trimble_support@trimble.com

Copyright and trademarks

© 2018, Trimble Inc. All rights reserved.

Trimble and the Globe & Triangle logo and Ranger are trademarks of Trimble Inc., registered in the United States and in other countries. Access is a trademark of Trimble Inc.

Spectra Precision and the Spectra Precision logo are trademarks of Trimble Inc. or its subsidiaries.

Microsoft and Windows are either registered trademarks or trademarks of Microsoft Corporation in the United States and/or other countries.

The Bluetooth word mark and logos are owned by the Bluetooth SIG, Inc. and any use of such marks by Trimble Inc. is under license.

All other trademarks are the property of their respective owners.

Release Notice

This is the August 2018 release (Revision B) of the Spectra Precision Ranger 7 data collector documentation.

European declaration of conformity

According to ISO / IEC Guide 22 and EN 450 14

Manufacturer's Name: Trimble Inc..

Manufacturer's Address: 935 Stewart Drive, Sunnyvale CA 94085, USA

Declares, under our sole responsibility, that the product:

Product Name: Ranger 7

Model Number: 121300

Conforms to the following Product Specifications:

- R&TTE Directive 1999/5/EC ETSI EN 300 328 V1.8.1 (2012-06) ETSI EN 301 489-1 V1.9.2 (2011-09)
- ETSI EN 301 489-17 V2.2.1 (2012-09)
- EN 55022: 2010+AC: 2011
- EN 55024: 2010
- EN 60950-1 (2001)
- EN 61000-3-2: 2006+A2: 2009
- EN 61000-3-3: 2013

Supplementary information

In addition, the product is battery powered and the power supply provided with this product has been certified to IEC 60950 +A1, A2, A3, A4, A11. As manufacturer, we declare under our sole responsibility that the equipment follows the provisions of the Standards stated above.

Importer of Record

Trimble European Regional Fulfillment Center
Logistics Manager
Meerheide 45
55521 DZ Eersel
Netherlands.

Trimble EC

Trimble Germany
Am Princ Parc 11
65479 Raunheim
Germany

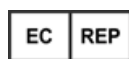

CAUTION - Only approved accessories may be used with this equipment. In general, all cables must be high quality, shielded, correctly terminated and normally restricted to two meters in length. Power supplies approved for this product employ special provisions to avoid radio interference and should not be altered or substituted. Unapproved modifications or operations beyond or in conflict with these instructions for use may void authorization by the authorities to operate the equipment.

Recycling information

You should dispose of the device and accessories properly according to local laws and regulations. Because the device contains electronic components, it must be disposed of separately from household waste. When the device reaches its end of life, contact your local Spectra Precision reseller to learn about disposal and recycling options for your area.

Recycling in Europe

The symbol at right means that according to local laws and regulations your product and/or its battery shall be disposed of separately from household waste. When this product reaches its end of life, take it to a collection point designated by local authorities. The separate collection and recycling of your product and/or its battery at the time of disposal will help conserve natural resources and ensure that it is recycled in a manner that protects human health and the environment.



For information about recycling Trimble WEEE (Waste Electrical and Electronic Equipment) products that run on electrical power go to http://www.trimble.com/corporate/about_WEEE_ROHS_initiatives.aspx.

To recycle Trimble WEEE products call +31 497 53 24 30, and ask for the "WEEE Associate". or mail a request for recycling instructions to:

Trimble Europe B.V. WEEE Recycling
C/O Menlo logistics
Gate 19 to 26
Meerheide 43
5521 DZ
Eersel
The Netherlands

Taiwan – Battery Recycling Requirements

The product contains a Lithium-ion battery. Taiwanese regulations require that waste batteries are recycled.



廢電池請回收

Regional compliance

Australia and New Zealand

This product conforms with the regulatory requirements of the Australian Communications and Media Authority (ACMA) Telecommunications, Radiocommunications and EMC Labelling Notices, thus satisfying the requirements for RCM marking and sale within Australia and New Zealand.



Europe

This Trimble product has been tested and found to comply with all requirements for CE Marking and sale within the European Economic Area (EEA). The device has Bluetooth and wireless LAN approval and satisfies the requirements for Radio and Telecommunication Terminal Equipment specified by European Council Directive 1999/5/EC. These requirements provide reasonable protection against harmful interference when the equipment is operated appropriately in a residential or commercial environment.



The device is intended for connection to European Networks operating on GSM 900, or GSM 1800 MHz.

Canada

IC ID:5817A-121300

This digital apparatus does not exceed the Class B limits for radio noise emissions from digital apparatus as set out in the radio interference regulations of the Canadian Department of Communications.

Le présent appareil numérique n'émet pas de bruits radioélectriques dépassant les limites applicables aux appareils numériques de Classe B prescrites dans le règlement sur le brouillage radioélectrique édicté par le Ministère des Communications du Canada.

Changes and modifications not expressly approved by the manufacturer or registrant of this equipment can void your

authority to operate this equipment under Industry Canada rules.

Les changements et modifications non expressément approuvés par le fabricant ou le détenteur de cet équipement peuvent annuler votre droit à utiliser cet appareil en vertu des règles d'Industrie Canada.

Antenna Statement

Under Industry Canada regulations, this radio transmitter may only operate using an antenna of a type and maximum (or lesser) gain approved for the transmitter by Industry Canada. To reduce potential radio interference to other users, the antenna type and its gain should be so chosen that the equivalent isotropically radiated power (e.i.r.p.) is not more than that necessary for successful communication.

Conformément à la réglementation d'Industrie Canada, le présent émetteur radio peut fonctionner avec une antenne d'un type et d'un gain maximal (ou inférieur) approuvé pour l'émetteur par Industrie Canada. Dans le but de réduire les risques de brouillage radioélectrique à l'intention des autres utilisateurs, il faut choisir le type d'antenne et son gain de sorte que la puissance isotrope rayonnée équivalente (p.i.r.e.) ne dépasse pas l'intensité nécessaire à l'établissement d'une communication satisfaisante.

Licence exempt

This device complies with Industry Canada licence-exempt RSS standard(s). Operation is subject to the following two conditions:

- (1) this device may not cause interference, and
- (2) this device must accept any interference, including interference that may cause undesired operation of the device.

Le présent appareil est conforme aux CNR d'Industrie Canada applicables aux appareils radio exempts de licence. L'exploitation est autorisée aux deux conditions suivantes :

- (1) l'appareil ne doit pas produire de brouillage, et
- (2) l'utilisateur de l'appareil doit accepter tout brouillage radioélectrique subi, même si le brouillage est susceptible d'en compromettre le fonctionnement.

This Class B digital apparatus complies with Canadian ICES-003.

Cet appareil numérique de la classe B est conforme à la norme NMB-003 du Canada.

This Category II radio communication device complies with Industry Canada Standard RSS-310.

Ce dispositif de radiocommunication de catégorie II respecte la norme CNR-310 d'Industrie Canada.

IMPORTANT NOTE: IC Radiation Exposure Statement

This EUT is compliant with SAR for general population/uncontrolled exposure limits in IC RSS-102 and had been tested in accordance with the measurement

methods and procedures specified in IEEE 1528. This equipment should be installed and operated with minimum distance 0.5 cm between the radiator & your body. This device and its antenna(s) must not be co-located or operating in conjunction with any other antenna or transmitter. The County Code Selection feature is disabled for products marketed in the US/Canada.

IC SAR warning

Radio Frequency (RF) Exposure Information

The radiated output power of the Wireless Device is below the Industry Canada (IC) radio frequency exposure limits. The Wireless Device should be used in such a manner such that the potential for human contact during normal operation is minimized.

This device has been evaluated for and shown compliant with the IC Specific Absorption Rate ("SAR") limits when installed in specific host products operated in portable exposure conditions.

Informations concernant l'exposition aux fréquences radio (RF)

La puissance de sortie émise par l'appareil de sans fil est inférieure à la limite d'exposition aux fréquences radio d'Industry Canada (IC). Utilisez l'appareil de sans fil de façon à minimiser les contacts humains lors du fonctionnement normal.

Ce périphérique a été évalué et démontré conforme aux limites SAR (Specific Absorption Rate – Taux d'absorption spécifique) d'IC lorsqu'il est installé dans des produits hôtes particuliers qui fonctionnent dans des conditions d'exposition à des appareils portables.

The device could automatically discontinue transmission in case of absence of information to transmit, or operational failure. Note that this is not intended to prohibit transmission of control or signaling information or the use of repetitive codes where required by the technology.

The device for the band 5150-5250 MHz is only for indoor usage to reduce potential for harmful interference to co-channel mobile satellite systems; the maximum antenna gain permitted (for devices in the bands 5250-5350 MHz and 5470-5725 MHz) to comply with the e.i.r.p. limit; and The maximum antenna gain permitted (for devices in the band 5725-5850 MHz) to comply with the e.i.r.p. limits specified for point-to-point and non-point-to-point operation as appropriate, as stated in section A9.2(3). In addition, High-power radars are allocated as primary users (meaning they have priority) of the band 5250-5350 MHz and this radar could cause interference and/or damage to LE-LAN devices.

U.S.

FCC ID:121300

FCC Compliance Statement

This equipment has been tested and found to comply with the limits for a Class B digital device pursuant to Part 15 of the FCC Rules. Operation is subject to the following two conditions: (1) this device may not cause harmful interference, and (2) this device must accept any interference received, including interference that may cause undesired operation.

This equipment generates, uses, and can radiate radio frequency energy and, if not installed and used in accordance with the instructions may cause harmful interference to radio communication. However, there is no guarantee that interference will not occur in a particular installation. If this equipment does cause harmful interference to radio or television reception, which can be determined by turning the equipment off and on, the user is encouraged to try to correct the interference by one or more of the following measures:

- Reorient or relocate the receiving antenna.
- Increase the separation between the equipment and the receiver.
- Connect the equipment into an outlet on a circuit different from that to which the receiver is connected.
- Consult the dealer or an experienced radio/TV technician for help.

Changes and modifications not expressly approved by the manufacturer or registrant of this equipment can void your authority to operate this equipment under Federal Communications Commission rules.

The radios in this device have been designed and manufactured to not exceed stipulated emission limits for exposure to radio frequency (RF) energy as required by the Federal Communications Commission of the U.S. Government 47 C.F.R. § 2.1091 and 2.1093.

Operation on the 5.15-5.25GHz frequency band is restricted to indoor use only. The FCC requires indoor use for the 5.15-5.25GHz band to reduce the potential for harmful interference to co-channel Mobile Satellite Systems. Therefore, it will only transmit on the 5.25-5.35 GHz, 5.47-5.725 GHz and 5.725 –5.850 GHz band when associated with an access point (AP).

CE

a. Caution:

- Risk of explosion if battery replaced by an incorrect type.
- Dispose of used batteries according to the instructions.

b. Make sure the temperature for adapter will not be higher than 40 °C.

Limited Warranty Terms and Conditions

Product Limited Warranty

Subject to the terms and conditions set forth herein, Trimble Inc. ("Trimble") warrants that for a period of two (2) years from date of purchase this Trimble product (the "Product") will substantially conform to Trimble's publicly available specifications for the Product and that the hardware and any storage media components of the Product will be substantially free from defects in materials and workmanship.

Product Software

Product software, whether built into hardware circuitry as firmware, provided as a standalone computer software product, embedded in flash memory, or stored on magnetic or other media, is licensed solely for use with or as an integral part of the Product and is not sold. The terms of the end user license agreement, as included below, govern the use of the Product Software, including any differing limited warranty terms, exclusions and limitations, which shall control over the terms and conditions set forth in the limited Product warranty.

Warranty Remedies

If the Trimble Product fails during the warranty period for reasons covered by this limited warranty and you notify Trimble of such failure during the warranty period, Trimble will repair OR replace the nonconforming Product with new, equivalent to new, or reconditioned parts or Product, OR refund the Product purchase price paid by you, at Trimble's option, upon your return of the Product in accordance with Trimble's product return procedures then in effect.

How to Obtain Warranty Service

To obtain warranty service for the Product, it is recommended you contact your Trimble dealer. Alternatively, you may contact Trimble to request warranty service by emailing Repair_Services@Trimble.com. Please be prepared to provide:

- your name, address, and telephone numbers;
- product name, part number and serial number;
- proof of purchase;
- an explanation of the problem.

The customer service representative may need additional information from you depending on the nature of the problem.

Warranty Exclusions and Disclaimer

This Product limited warranty shall only apply in the event and to the extent that (i) the Product is properly and correctly installed, configured, interfaced, maintained, stored, and operated in accordance with Trimble's applicable operator's manual and specifications, and; (ii) the Product is not modified or misused. This Product limited warranty shall not apply to,

and Trimble shall not be responsible for, defects or performance problems resulting from (i) the combination or utilization of the Product with hardware or software products, information, data, systems, interfaces, or devices not made, supplied, or specified by Trimble; (ii) the operation of the Product under any specification other than, or in addition to, Trimble's standard specifications for its products; (iii) the unauthorized installation, modification, or use of the Product; (iv) damage caused by: accident, lightning or other electrical discharge, fresh or salt water immersion or spray (outside of Product specifications); or exposure to environmental conditions for which the Product is not intended; (v) normal wear and tear on consumable parts (e.g., batteries); or (vi) cosmetic damage. Trimble does not warrant or guarantee the results obtained through the use of the Product or Software, or that software components will operate error free.

NOTICE REGARDING PRODUCTS EQUIPPED WITH TECHNOLOGY CAPABLE OF TRACKING SATELLITE SIGNALS FROM SATELLITE BASED AUGMENTATION SYSTEMS (SBAS) (WAAS, EGNOS, GAGAN, MSAS AND LUCH), OMNISTAR, BEIDOU, GPS, GALILEO OR GLONASS SATELLITES, OR FROM IALA BEACON SOURCES: TRIMBLE IS NOT RESPONSIBLE FOR THE OPERATION OR FAILURE OF OPERATION OF ANY SATELLITE BASED POSITIONING SYSTEM OR THE AVAILABILITY OF ANY SATELLITE BASED POSITIONING SIGNALS.

THE FOREGOING LIMITED WARRANTY TERMS STATE TRIMBLE'S ENTIRE LIABILITY, AND YOUR EXCLUSIVE REMEDIES, RELATING TO THE TRIMBLE PRODUCT. EXCEPT AS OTHERWISE EXPRESSLY PROVIDED HEREIN, THE PRODUCT, AND ACCOMPANYING DOCUMENTATION AND MATERIALS ARE PROVIDED "AS-IS" AND WITHOUT EXPRESS OR IMPLIED WARRANTY OF ANY KIND, BY EITHER TRIMBLE OR ANYONE WHO HAS BEEN INVOLVED IN ITS CREATION, PRODUCTION, INSTALLATION, OR DISTRIBUTION, INCLUDING, BUT NOT LIMITED TO, THE IMPLIED WARRANTIES OF MERCHANTABILITY AND FITNESS FOR A PARTICULAR PURPOSE, TITLE, AND NONINFRINGEMENT. THE STATED EXPRESS WARRANTIES ARE IN LIEU OF ALL OBLIGATIONS OR LIABILITIES ON THE PART OF TRIMBLE ARISING OUT OF, OR IN CONNECTION WITH, ANY PRODUCT. BECAUSE SOME STATES AND JURISDICTIONS DO NOT ALLOW LIMITATIONS ON DURATION OR THE EXCLUSION OF AN IMPLIED WARRANTY, THE ABOVE LIMITATION MAY NOT APPLY TO YOU.

Limitation of Liability

TRIMBLE'S ENTIRE LIABILITY UNDER ANY PROVISION HEREIN SHALL BE LIMITED TO THE AMOUNT PAID BY YOU FOR THE PRODUCT. TO THE MAXIMUM EXTENT PERMITTED BY APPLICABLE LAW, IN NO EVENT SHALL TRIMBLE OR ITS SUPPLIERS BE LIABLE FOR ANY INDIRECT, SPECIAL, INCIDENTAL, OR CONSEQUENTIAL DAMAGE WHATSOEVER.

UNDER ANY CIRCUMSTANCE OR LEGAL THEORY RELATING IN ANYWAY TO THE PRODUCTS, SOFTWARE AND ACCOMPANYING DOCUMENTATION AND MATERIALS, (INCLUDING, WITHOUT LIMITATION, DAMAGES FOR LOSS OF BUSINESS PROFITS, BUSINESS INTERRUPTION, LOSS OF DATA, OR ANY OTHER PECUNIARY LOSS), REGARDLESS OF WHETHER TRIMBLE HAS BEEN ADVISED OF THE POSSIBILITY OF ANY SUCH LOSS AND REGARDLESS OF THE COURSE OF DEALING WHICH DEVELOPS OR HAS DEVELOPED BETWEEN YOU AND TRIMBLE. BECAUSE SOME STATES AND JURISDICTIONS DO NOT ALLOW THE EXCLUSION OR LIMITATION OF LIABILITY FOR CONSEQUENTIAL OR INCIDENTAL DAMAGES, THE ABOVE LIMITATION MAY NOT APPLY TO YOU.

NOTE: THE ABOVE TRIMBLE LIMITED WARRANTY PROVISIONS WILL NOT APPLY TO PRODUCTS PURCHASED IN THOSE JURISDICTIONS (E.G., MEMBER STATES OF THE EUROPEAN ECONOMIC AREA) IN WHICH PRODUCT WARRANTIES ARE THE RESPONSIBILITY OF THE LOCAL DEALER FROM WHOM THE PRODUCTS ARE ACQUIRED. IN SUCH A CASE, PLEASE CONTACT YOUR TRIMBLE DEALER FOR APPLICABLE WARRANTY INFORMATION.

Notice to Australian Purchasers - The Australian Consumer Law

Our goods come with guarantees that cannot be excluded under the Australian Consumer Law. You are entitled to a replacement or refund for a major failure and for compensation for any other reasonably foreseeable loss or damage. You are also entitled to have the goods repaired or replaced if the goods fail to be of acceptable quality and the failure does not amount to a major failure.

Trimble's warranty, as set out in the user manual accompanying this statement, or as described in the warranty card accompanying the Product you purchased, is in addition to any mandatory rights and remedies that you may have under the Australian Consumer Law.

Official Language

THE OFFICIAL LANGUAGE OF THESE TERMS AND CONDITIONS IS ENGLISH. IN THE EVENT OF A CONFLICT BETWEEN ENGLISH AND OTHER LANGUAGE VERSIONS, THE ENGLISH LANGUAGE SHALL CONTROL

End User License Agreement for Product Software

IMPORTANT, READ CAREFULLY. THIS END USER LICENSE AGREEMENT ("EULA") IS A LEGAL AGREEMENT BETWEEN YOU AND Trimble Inc. ("Trimble") and applies to the computer software provided with the Trimble product purchased by you (whether built into hardware circuitry as firmware, embedded in flash memory, or stored on magnetic or other media), or provided as a stand-alone computer software product, and includes any accompanying written materials such as a user's

guide or product manual, as well as any "online" or electronic documentation ("Software" or "Product Software"). This EULA will also apply to any Software error corrections, updates and upgrades subsequently furnished by Trimble, unless such are accompanied by different license terms and conditions, which will govern their use. You have acquired a Trimble Product ("Device") that includes Software, some of which was licensed by Trimble from Microsoft Corporation or its affiliates (collectively "Microsoft"). The Software licensed from Microsoft, as well as associated updates, supplements, internet-based services and support services, media, printed materials, and "online" or electronic documentation ("Microsoft Software"), are protected under this EULA. The Software is also protected by copyright laws and international copyright treaties, as well as other intellectual property laws and treaties. The Software is licensed, not sold. BY USING THE SOFTWARE, INCLUDING USE ON THIS DEVICE, YOU ACCEPT THESE TERMS. IF YOU DO NOT ACCEPT THEM, DO NOT USE THE DEVICE OR SOFTWARE. INSTEAD CONTACT TRIMBLE FOR A REFUND OR CREDIT. As described below, using some features also operates as your consent to the transmission of certain standard computer information for Internet-based services.

WARNING - If the Software contains voice operated technologies, then operating this Software requires user attention. Diverting attention away from the road while driving can possibly cause an accident or other serious consequence. Even occasional, short diversions of attention can be dangerous if your attention is diverted away from your driving task at a critical time. Trimble and Microsoft make no representations, warranties or other determinations that ANY use of this Software is legal, safe, or in any manner recommended or intended while driving or otherwise operating a motor vehicle.

1 LIMITED WARRANTY FOR TRIMBLE PRODUCT SOFTWARE

1.1 Limited Warranty. Trimble warrants that the Software, exclusive of the Microsoft Software, will perform substantially in accordance with the accompanying written materials for a period of twelve (12) months from the date of purchase. This limited warranty gives you specific legal rights; you may have others, which vary from state/jurisdiction to state/jurisdiction. The above limited warranty does not apply to Fixes, Minor Updates, or Major Upgrades of the Software after expiration of the twelve (12) month limited warranty period, all of which are provided "AS IS" and without warranty unless otherwise specified in writing by Trimble. Because the Software is inherently complex and may not be completely free of nonconformities, defects or errors, you are advised to verify your work. Trimble does not warrant that the Software will operate error free or uninterrupted, will meet your needs or

expectations, or that all nonconformities can or will be corrected.

1.2 Software Fixes. During the limited warranty period described in section 1.1 above, you will be entitled to receive such Fixes to the Product Software that Trimble releases and makes commercially available and for which it does not charge separately, subject to the procedures for delivery to purchasers of Trimble products generally. If you have purchased the Product from an authorized Trimble dealer rather than from Trimble directly, Trimble may, at its option, forward the software Fix to the Trimble dealer for final distribution to you. Minor Updates, Major Upgrades, new products, or substantially new software releases, as identified by Trimble, are expressly excluded from this update process and limited warranty. Receipt of Software Fixes or other enhancements shall not serve to extend the limited warranty period.

For purposes of this warranty the following definitions shall apply: (1) "Fix(es)" means an error correction or other update created to fix a previous software version that does not substantially conform to its Trimble specifications; (2) "Minor Update" occurs when enhancements are made to current features in a software program; and (3) "Major Upgrade" occurs when significant new features are added to software, or when a new product containing new features replaces the further development of a current product line. Trimble reserves the right to determine, in its sole discretion, what constitutes a Fix, Minor Update, or Major Upgrade.

1.3 Customer Remedies. Trimble's and its suppliers' entire liability, and your sole remedy, with respect to the Software shall be either, at Trimble's option, (a) repair or replacement of the Software, or (b) return of the license fee paid for any Software that does not meet Trimble's limited warranty. This limited warranty is void if failure of the Software has resulted from (1) accident, misuse, abuse, or misapplication; (2) alteration or modification of the Software without Trimble's authorization; (3) interaction with software or hardware not supplied or supported by Trimble; (4) your improper, inadequate or unauthorized installation, maintenance or storage; or (5) if you violate the terms of this EULA. Any replacement Software will be warranted for the remainder of the original warranty period or thirty (30) days, whichever is longer.

1.4 NO OTHER WARRANTIES. TO THE MAXIMUM EXTENT PERMITTED BY APPLICABLE LAW, TRIMBLE AND ITS SUPPLIERS DISCLAIM ALL OTHER WARRANTIES, TERMS AND CONDITIONS, EITHER EXPRESS OR IMPLIED, BY STATUTE, COMMON LAW OR OTHERWISE, INCLUDING BUT NOT LIMITED TO, IMPLIED WARRANTIES, TERMS AND CONDITIONS OF MERCHANTABILITY AND FITNESS FOR A PARTICULAR PURPOSE, TITLE, AND NON-INFRINGEMENT WITH REGARD TO THE SOFTWARE, ITS SATISFACTORY QUALITY AND THE PROVISION OF OR FAILURE TO PROVIDE

SUPPORT SERVICES. TO THE EXTENT ALLOWED BY APPLICABLE LAW, IMPLIED WARRANTIES, TERMS AND CONDITIONS ON THE SOFTWARE ARE LIMITED TO NINETY (90) DAYS. YOU MAY HAVE OTHER LEGAL RIGHTS WHICH VARY FROM STATE/JURISDICTION TO STATE/JURISDICTION.

NO WARRANTIES FOR THE MICROSOFT SOFTWARE. THE MICROSOFT SOFTWARE is provided "AS IS" and with all faults, AND TRIMBLE PROVIDES NO WARRANTY WITH RESPECT THERETO. THE ENTIRE RISK AS TO SATISFACTORY QUALITY, PERFORMANCE,

ACCURACY AND EFFORT (INCLUDING LACK OF NEGLIGENCE) FOR THE MICROSOFT SOFTWARE IS WITH YOU. ALSO, THERE IS NO WARRANTY AGAINST INTERFERENCE WITH YOUR ENJOYMENT OF THE MICROSOFT SOFTWARE OR AGAINST INFRINGEMENT.

1.5 PLEASE NOTE: THE FOREGOING TRIMBLE LIMITED WARRANTY PROVISIONS MAY NOT APPLY TO SOFTWARE PRODUCT LICENSES PURCHASED IN THOSE JURISDICTIONS (SUCH AS COUNTRIES OF THE EUROPEAN UNION) IN WHICH PRODUCT WARRANTIES ARE OBTAINED FROM THE LOCAL DISTRIBUTOR. IN SUCH CASES, PLEASE CONTACT YOUR TRIMBLE DEALER FOR APPLICABLE WARRANTY INFORMATION.

2 TRIMBLE LIMITATION OF LIABILITY

2.1 LIMITATION OF LIABILITY. TO THE MAXIMUM EXTENT PERMITTED BY APPLICABLE LAW, IN NO EVENT SHALL TRIMBLE OR ITS SUPPLIERS BE LIABLE FOR ANY SPECIAL, INCIDENTAL, INDIRECT, CONSEQUENTIAL OR PUNITIVE DAMAGES HOWEVER CAUSED AND REGARDLESS OF THE THEORY OF LIABILITY (INCLUDING, WITHOUT LIMITATION, DAMAGES FOR LOSS OF BUSINESS PROFITS, BUSINESS INTERRUPTION, LOSS OF BUSINESS INFORMATION, OR ANY OTHER PECUNIARY LOSS) ARISING OUT OF THE USE OR INABILITY TO USE THE SOFTWARE, OR THE PROVISION OF OR FAILURE TO PROVIDE SUPPORT SERVICES, EVEN IF TRIMBLE HAS BEEN ADVISED OF THE POSSIBILITY OF SUCH DAMAGES AND NOTWITHSTANDING ANY FAILURE OF ESSENTIAL PURPOSE OF ANY EXCLUSIVE REMEDY PROVIDED IN THIS EULA.

IN NO EVENT SHALL THE TOTAL CUMULATIVE LIABILITY OF TRIMBLE AND ITS SUPPLIERS IN CONNECTION WITH THIS EULA OR THE SOFTWARE, WHETHER BASED ON CONTRACT, WARRANTY, TORT (INCLUDING NEGLIGENCE), STRICT LIABILITY OR OTHERWISE, EXCEED THE ACTUAL AMOUNT PAID TO TRIMBLE FOR THE SOFTWARE LICENSE GIVING RISE TO THE CLAIM. BECAUSE SOME STATES AND JURISDICTIONS DO NOT ALLOW THE EXCLUSION OR LIMITATION OF LIABILITY FOR CONSEQUENTIAL OR INCIDENTAL DAMAGES, THE ABOVE LIMITATION MAY NOT APPLY TO YOU.

3 GENERAL

3.1 This EULA shall be governed by the laws of the State of California and applicable United States Federal law without reference to "conflict of laws" principles or provisions. The United Nations Convention on Contracts for the International Sale of Goods will not apply to this EULA. Jurisdiction and venue of any dispute or court action arising from or related to this EULA or the Software shall lie exclusively in or be transferred to the courts the County of Santa Clara, California, and/or the United States District Court for the Northern District of California. You hereby consent and agree not to contest, such jurisdiction, venue and governing law.

3.2 Section 3.1 notwithstanding, if you acquired this product in Canada, this EULA is governed by the laws of the Province of Ontario, Canada. In such case each of the parties to this EULA irrevocably attorns to the jurisdiction of the courts of the Province of Ontario and further agrees to commence any litigation that may arise under this EULA in the courts located in the Judicial District of York, Province of Ontario. If you acquired this product in the European Union, this EULA is governed by the laws of The Netherlands, excluding its rules governing conflicts of laws and excluding the United Nations Convention on the International Sale of Goods. In such case each of the parties to this EULA irrevocably attorns to the jurisdiction of the courts of The Netherlands and further agrees to commence any litigation that may arise under this EULA in the courts of The Hague, The Netherlands.

3.3 Trimble reserves all rights not expressly granted by this EULA.

3.4 Official Language. The official language of this EULA and of any documents relating thereto is English. For purposes of interpretation, or in the event of a conflict between English and versions of this EULA or related documents in any other language, the English language version shall be controlling.

Contents

Safety information	12
Battery safety	12
Power supply safety	13
Touchscreen glass	13
Service safety	14
Safe environments of use	14
Distraction	14
Telecommunications & Internet Association (TIA)	14
SAR	15
Caring for your device	15
Cleaning	15
Touchscreen care	15
Battery care	16
Product specifications	17
1 Introduction	19
Registration	20
Configuration options	20
In the box	20
Replacement and spare or optional accessories	20
Parts of the Ranger 7 data collector	22
2 Basic setup and operation	25
Inserting SD and SIM cards	26
Attaching the handstrap	27
Tethering the stylus	28
Installing a screen protector	29
Installing and removing the batteries	32
Installing the batteries	32
Removing / hot-swapping a battery	33
Charging and power modes	33
Charging the battery	33
Checking the battery level	33
LED charging status	34
Turning the device on	34
Saving battery power	34
Wake and unlock	35

Restart the device	35
Turning off the device	35
Power options	35
Making your battery last longer	35
Using the touchscreen	36
Using the onscreen keypad	37
Using the stylus	38
Using the keypad	38
Modifier keys and Sticky keys	41
Configuring built-in keypad settings	42
Status icons in the taskbar	45
Pinning keypad status icons to the Taskbar	45
Using SYM Key IME	46
3 Using the Windows 10 operating system	51
Using accounts	51
Sign in	51
Sign out	52
Using the Start menu	52
Using the Action Center	52
Using the Windows Mobility Center	53
Using Task View and virtual desktops	53
Settings	54
Display settings: adjusting the backlight	54
Display settings: rotation lock	55
4 Using wireless networks	56
Working with Wi-Fi networks	56
Connecting to Wi-Fi	56
Disconnecting from a Wi-Fi network	57
Forgetting a Wi-Fi network	57
Working with mobile broadband	57
Connecting to mobile broadband	57
Locating the device's IMEI number	58
Airplane mode	58
5 Working with GNSS	60
Using the uBlox uCenter application	60

6	Using accessories and connecting to other devices	61
	Connecting to USB accessories	61
	Connecting to Bluetooth accessories	61
	Connecting to RS-232 peripherals	62
	Transferring data between your Ranger 7 data collector and another computer	63
	Using EMPOWER modules	63
	Installing EMPOWER modules	63
	Using the pole mount	65
	Using the shoulder sling	65
	Using the desktop hub	65
7	Using the cameras	67
	Taking photos and videos	67
	Changing camera settings	68
	Enable the Camera app to access your location to geo-tag photos	68
	Viewing photos and videos	68
8	Using the pre-installed apps	69
	Trimble EMPOWER Hub	69
	Bundled Microsoft apps	69
	Getting more apps	70
9	Troubleshooting, downloading updates, and repair	71
	Troubleshooting	71
	Further assistance and support with the Windows 10 Pro operating system	71
	Performance issues	71
	EMPOWER module issues	72
	Wireless connectivity issues	73
	Power and battery issues	73
	Restarting or resetting the operating system	74
	Operating system and software updates	75
	Windows 10 updates	75
	Software downloads and updates	76
	Repairing your device	76

Safety information

- ▶ Battery safety
- ▶ Power supply safety
- ▶ Touchscreen glass
- ▶ Service safety
- ▶ Safe environments of use
- ▶ Distraction
- ▶ Telecommunications & Internet Association (TIA)
- ▶ SAR
- ▶ Caring for your device

Read this guide for important safety and health information and the terms of the Limited Warranty that apply to the Spectra Precision® Ranger 7 data collector that you have purchased. Keep all printed guides for future reference. Failure to follow instructions and properly set up, use, and care for this product can increase the risk of serious injury or death, or damage the device or devices.

Battery safety

Lithium-Ion batteries are classified by the U. S. Federal Government as non-hazardous waste and are safe for disposal in the normal municipal waste stream. These batteries contain recyclable materials and are accepted for recycling. Dispose of used batteries in accordance with local regulations.

 **WARNING** – Non-approved batteries will not function in the device. Use only the battery for the system for which it was specified. Only use the battery with a charging system that has been qualified with the system per this standard. Use of an unqualified battery or charger may present a risk of fire, explosion, leakage, or other hazard.

 **WARNING** – There are no user-serviceable parts in the batteries. Do not disassemble or open, crush, bend or deform, puncture, or shred the battery. Do not modify or remanufacture, attempt to insert foreign objects into the battery, immerse or expose to water or other liquids, or expose to fire, explosion, or other hazard. Do not expose to temperatures above +70 °C (+158 °F).

 **WARNING** – Improper battery use may result in a fire, explosion, or other hazard.

- Do not short circuit a battery or allow metallic or conductive objects to contact the battery terminals.
 - Avoid dropping the device or battery. If dropped, especially on a hard surface, and the user suspects damage to the battery, take it to a service center for inspection.
 - In the event of a battery leak, do not allow the liquid to come in contact with the skin or eyes. If contact has been made, wash the affected area with large amounts of water and seek medical advice.
 - Battery usage by children should be supervised.
-

Power supply safety

 **WARNING** – Use only AC and vehicle adapters intended for the device. Other external power sources may damage your product and void the warranty.

- Ensure the input voltage on the adapter matches the voltage in your location. Ensure the adapter has prongs compatible with your outlets.
 - The AC power supply is designed for indoor use only. Avoid using the AC power supply in wet areas.
 - Unplug the power supply from power when not in use.
 - Do not short the output connector.
-

Touchscreen glass

 **CAUTION** – The touchscreen on this device is made of glass. This glass could break if the device is dropped on a hard surface or receives a significant impact. If the glass chips or cracks, do not touch or attempt to remove the broken glass. Cracked or chipped glass due to misuse or abuse is not covered under the product's limited warranty.

Service safety

 **WARNING** – Do not attempt to take apart, open, service, or modify the product, accessories, or power supply. Doing so could present the risk of electric shock or other hazard. Any evidence of any attempt to open and/or modify this device, including any peeling, puncturing, or removal of any of the labels, will void the Limited Warranty.

Safe environments of use

 **WARNING** – Areas with potentially explosive atmospheres are often, but not always, posted and can include fueling areas, such as below decks on boats, fuel or chemical transfer or storage facilities, or areas where the air contains chemicals or particles, such as grain dust, or metal powders. When you are in such an area, turn off your mobile device, and do not remove or install battery chargers, AC adapters, or any other accessory. In such areas, sparks can occur and cause an explosion or fire.

Distraction

 **WARNING** – Using the device in some circumstances can distract you and may cause a dangerous situation. Observe rules that prohibit or restrict the use of mobile devices (for example, avoid operating the device while driving a vehicle).

Telecommunications & Internet Association (TIA)

Hearing Aids: Some digital wireless phones may interfere with some hearing aids. In the event of such interference, you may want to consult your service provider, or call the customer service line to discuss alternatives.

Pacemakers and Other Medical Devices: The Health Industry Manufacturers Association recommends a minimum separation of six inches be maintained between a handheld wireless phone and a pacemaker to avoid potential interference with the pacemaker. These recommendations are consistent with the independent research by and recommendations of Wireless Technology Research. Persons with pacemakers should use the ear opposite the pacemaker to minimize the potential for interference. If you have any reason to suspect that interference is taking place, turn the phone OFF immediately.

If you use any other personal medical device, consult the manufacturer of your device to determine if they are adequately shielded from external RF energy. Your physician may be able to assist you in obtaining this information.

Turn the phone OFF in health care facilities when any regulations posted in these areas instruct you to do so. Hospitals or health care facilities may be using equipment that could be sensitive to external RF energy.

SAR

This device complies with FCC and CE standards when used as designed.

Caring for your device

Cleaning

Turn off the device, and disconnect it from external power. Use a soft, dampened cloth with either water or a diluted mild detergent. If a mild detergent is used, ensure all soap residue is removed. Do not use chemical cleaners.

Touchscreen care

The Ranger 7 data collector is extremely rugged, and is designed to withstand extreme conditions and harsh treatment, however taking proper care of the touchscreen will prolong the life and ensure optimal display performance of the touchscreen of this product. Excessive or prolonged exposure to abrasives, oil, dust, chemicals, and ultraviolet light can affect the performance of your touchscreen over time.

To help protect the screen:

- **Clean it frequently.** Use a soft, lint-free cloth to wipe the screen. You can dampen the cloth with water or an eyeglass cleaner. If the display is very dirty, it can be washed off under a gently running tap.

 **WARNING** – Make sure that all ports and doors are fully closed, and that the device is not connected to an external power supply. Do not use chemical or abrasive cleaners.

- **Keep it covered when not in use.** Store the Ranger 7 data collector in a carry case or pouch while you are in transit or not using it.
- **Keep it out of the sun when not in use.** Do not store the Ranger 7 data collector in direct sunlight for a long time unnecessarily. Ultraviolet light and excessive heat from sun-loading heat can damage the display.
- **Use proper touchscreen tools.** Use either fingers or the Ranger 7 data collector's stylus pen, or other devices specifically designed for use with capacitive touchscreens to operate the touchscreen of this device. The use of ballpoint pens, metal tools or

other sharp objects to operate the touchscreen may scratch and/or damage the surface of the touchscreen.

- **Avoid drops, tumbles, and abrasives.** The Ranger 7 data collector is designed to resist damage for drops up to 122 cm (4 feet). However, you should protect the display from impact, pressure, and abrasive substances that can scratch it or crack it. The device should not be dropped unnecessarily. Use the screen protectors to keep the touchscreen clean and protected, following the instructions provided on the screen protector packaging.

Battery care

Use and storage temperature: Lithium-ion batteries are sensitive to high temperatures, so keep the device's batteries out of direct sun for long periods, and do not leave batteries in a hot car, especially on a dashboard in full sun or other environments where temperatures can exceed +70 °C (+158 °F). Battery life can be shortened if stored or operated outside of these temperature ranges. Recommended storage temperature is at room temperature (~ +20 °C / +68 °F). When you are using the device or charging the batteries, it is normal for the device and batteries to get warm.

If the interior temperature of the device exceeds normal operating temperatures (for example, in a hot car or in direct sunlight for extended periods of time), you may experience the following as it attempts to regulate its temperature automatically:

- The device stops charging.
- If the device cannot regulate its internal temperature, it may go into a Sleep state until it cools.

Move the device to a cooler location out of direct sunlight and wait a few minutes before trying to use the device again.

Charging: Recharge the battery any time; the battery does not need to be empty or low before you recharge it. However, it is best to let the battery run to below 10 percent at least once a month before you recharge it. Battery recharging is supported at temperatures between 0 °C and +40 °C (+32 °F and +104 °F). Use only the manufacturer designated charging accessories to recharge the batteries.

Other environmental conditions: The batteries are sealed from water and dust, and are tested for protection from drops from heights up to 1.22m. However to prolong the life of the battery, dry it off with a cloth if it becomes wet, do not intentionally submerge the battery, and take care to avoid unnecessary drops, mechanical shocks, and vibrations.

The Ranger 7 data collector is designed to work in ambient temperatures between -20 °C and +60 °C (-4 °F and +140 °F) and to be stored in temperatures between -40 °C and +70 °C (-40 °F and +148 °F). Avoid exposing the device to dramatic changes in temperature or humidity.

Product specifications

Operating System	Microsoft Windows 10 Pro
Processor	Intel® Apollo Lake - N4200, 64-bit quad-core
Graphics	Intel Graphics Architecture
RAM	8 GB RAM, LPDDR4
User storage	64 GB eMMC, expandable via SDXC card up to 2 TB
Display	7-inch, 1280 x 800 landscape, 16:10, multi-point capacitive, 650+ nits sunlight readable
Battery & Power	2 x 3100 mAh (22.53 Wh) min. capacity /3150 mAh (22.90 Wh) nominal capacity; removable, hot swappable, charge LED indicator Full-charge 3.5 hours, fast-charge (80 %) 1 ¾ hours
I/O	User replaceable module Standard: Charger/DC power-in, USB 3.1 Gen 1 type A host, serial RS232 DB-9
Audio	Speaker Dual digital microphone array with noise reduction External speaker/ microphone: 3.5 mm mini-jack or wireless headset
Bluetooth	BT 2.1 + EDR, BT 4.1
Wi-Fi	802.11 a/b/g/n, 2.4 GHz radio band
Mobile broadband / WWAN	Worldwide LTE in regions where it is available, and compatible with 3G networks AT&T and Verizon certified. MicroSIM card
GNSS	Integrated GNSS
Camera	Front: 2MP fixed focus Rear: 8MP auto focus with flash

Sensors	<p>3-axis accelerometer, magnetic sensor, ambient light sensor, proximity sensor.</p> <p>The orientation sensors are active and applications can access and use the sensors. For free tools that enable you to view sensor output, go to the Microsoft Store.</p>
Environmental	<p>IEC: Independently tested and certified for:</p> <ul style="list-style-type: none">• Water and Dust Ingress Protection: IP68 <p>MIL-STD-810G. Independently tested and certified for:</p> <ul style="list-style-type: none">• Operating temperature: -20 °C to +60 °C (-4 °F to +140 °F)• Storage temperature: -40 °C to +70 °C (-40 °F to +158 °F)• Humidity: 90 % RH temp cycle -20 °C/60 °C (-4 °F/140 °F)• 26 drops at room temperature from 1.22 m (4 ft) onto plywood over concrete MIL-STD-810G, Method 516.6, Procedure IV

Introduction

- ▶ Registration
- ▶ Configuration options
- ▶ In the box
- ▶ Replacement and spare or optional accessories
- ▶ Parts of the Ranger 7 data collector

This user guide describes how to configure and use the Spectra Precision Ranger 7 data collector powered by the Microsoft® Windows® 10 Pro operating system. The information in this guide supplements the information in the Quick Start Guide, which you receive in the box with the device.

Even if you have used other Spectra Precision handheld or field computers before, Spectra Precision recommends that you spend some time reading this guide to learn about the special features of the product.

 **WARNING** – Before you use this product, make sure that you have read and understood all safety requirements. Failure to follow these safety instructions could result in fire, electric shock, or other injury, or damage to the device and/or other property. For more information refer to [Safety information, page 12](#) of this guide.

Registration

To receive information regarding updates and new products, contact your local dealer or go to <https://mytrimbleprotected.com/cc/productsRegistration.html>.

To register your device, you will need the serial number. The serial number is a unique number for your Ranger 7 data collector and is located on a label inside the battery cavity.

Configuration options

The Ranger 7 data collector is powered by the Windows 10 Pro operating system, and is available with a full ABCD or QWERTY keypad, with North America or worldwide (ROW) WWAN, and with or without bundled software. See you local Spectra Precision reseller for information.

In the box

A standard pack-out has the following items:

- A Ranger 7 data collector
- 1 battery pack, which includes 2 batteries
- AC power adaptor with cable
- Tempered glass screen protector
- Stylus with tether
- Handstrap

Replacement and spare or optional accessories

A wide range of replacement and optional accessories are available to purchase for the Ranger 7 data collector, including:

- Hand Strap
- Shoulder Sling
- Pole Mount
- Desktop Hub
- Serial Data Cable, 1.0m (DB9 to DB9)
- Serial I/O Boot
- Serial I/O Boot (Alternative boot with 2 USB ports)
- AC Adapter w/ Int. Cord

- AC Adapter with CHN Cord
- 12V Vehicle Adapter
- Rechargeable Battery 2-pack
- External Battery Charger
- External Battery Charger w/ Int. Cord
- Ext. Battery Charger w/ Int. Cord, Battery 2-pack
- Glass Screen Protector
- Stylus with Tether

EMPOWER modules

The following EMPOWER modules are also available:

- EM120 2.4GHz Module
- EM100 GNSS Module
- EM111 1D/2D Barcode Imager & UHF 902-928 MHz RFID – NA
- EM111 1D/2D Barcode Imager & UHF 865.6-867.6 MHz RFID – EU

Parts of the Ranger 7 data collector

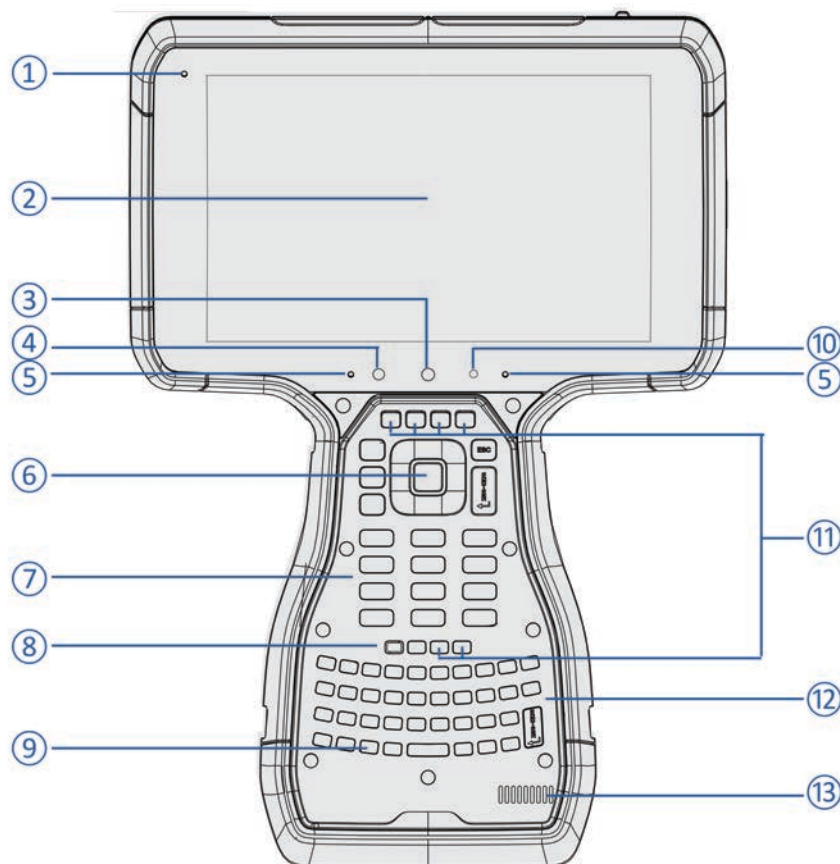

- | | | | |
|---|-------------------------------------|----|---|
| 1 | Power / Charging LED | 8 | Power Button |
| 2 | Touchscreen | 9 | Windows Key |
| 3 | Camera - Front
2 MP, Fixed-Focus | 10 | Front Camera LED;
Solid = On, Off = Off. |
| 4 | Light / Proximity Sensor | 11 | Function Keys (x 6). |
| 5 | Microphone - Left / Right | 12 | Full Keypad. QWERTY or ABC |
| 6 | OK Key | 13 | Speaker |
| 7 | Numeric Keypad | | |

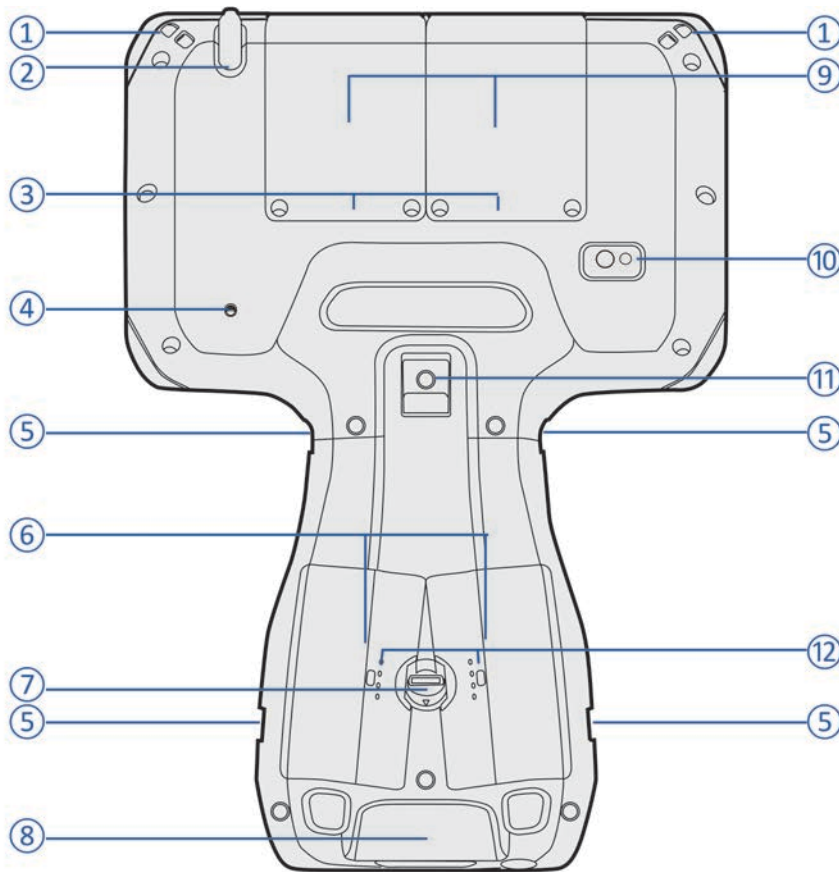

- | | | | |
|---|--|----|----------------------------------|
| 1 | Stylus Tether Points | 7 | Battery Lock |
| 2 | Stylus bay | 8 | Swappable / Replaceable I/O Boot |
| 3 | SD and SIM Card Slots, behind Modules / Module Bay Covers | 9 | EMPOWER Module Bays (x 2) |
| 4 | Stylus Bay Drainage Hole | 10 | Camera - Rear, 8 MP, Auto-Focus |
| 5 | Handstrap Connector Points | 11 | Pole Mount Latch |
| 6 | Hot-Swappable, Field-Swappable, Long Life Battery Pack (2 x Batteries) | 12 | Battery LEDs |

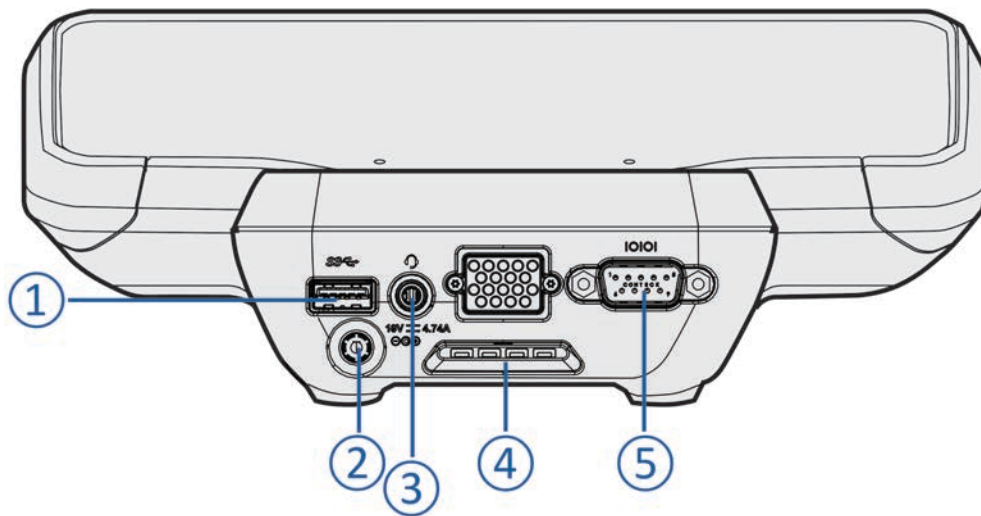

- 1 USB Connector
- 2 Charging Port
- 3 Audio Jack

- 4 Device Mount Hook
- 5 DB9 / RS232 Serial Connector

Basic setup and operation

- ▶ Inserting SD and SIM cards
- ▶ Attaching the handstrap
- ▶ Tethering the stylus
- ▶ Tethering the stylus
- ▶ Installing and removing the batteries
- ▶ Charging and power modes
- ▶ Using the touchscreen
- ▶ Using the keypad

This section tells you how to get started using your Ranger 7 data collector and explains some basic operating system features.

When you start your Ranger 7 data collector for the first time, the Microsoft Windows operating system will take you through some basic set-up steps; follow the instructions on the screen.

 **CAUTION** – When you first set up the device, make sure you select English US (Eng US) as the keypad language, independent of the keypad layout (ABCD or QWERTY) and the language you use on the Ranger 7 data collector.

For more details on setting up and using the Windows 10 operating system see [Get Started with Windows 10](#) on the Microsoft Windows support website.

Inserting SD and SIM cards

The device includes 64 GB of onboard storage. To expand the storage, use an SDXC card. SDXC cards up to up to 2 TB are supported.

To use cellular data, you will need a MicroSIM card and a data plan from your local cellular service provider to use this feature. See [Working with mobile broadband, page 57](#) for more information.

CAUTION – The SD/SIM card door can be damaged if handled carelessly. Take care not to twist or warp the door when opening or closing it.

1. If the device is on, turn it off; tap  / Power/ Shut down.
2. Using a Phillips screwdriver, loosen the screws to remove both the module bay covers from the back of the device.

NOTE – If you are using EMPOWER modules, remove them in the same way.

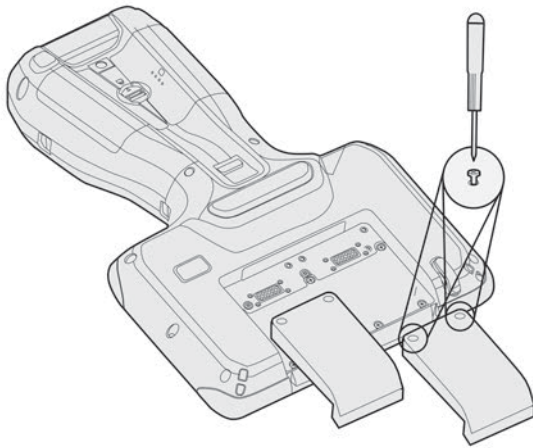

3. Using a Phillips screwdriver, remove the screws to open the SD/SIM bay door.
4. Place the SD card and the SIM card into their respective slots.

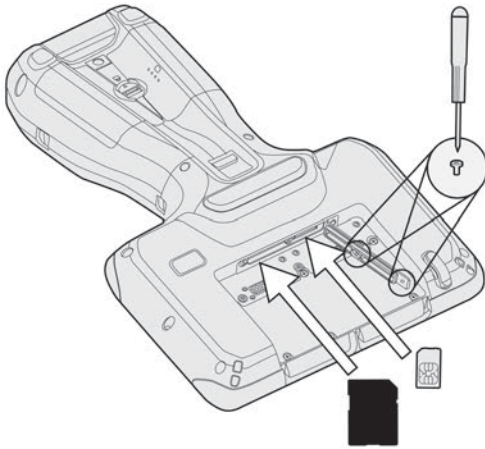

5. Close the SD/SIM bay door, and tighten the screws.
6. Replace the module bay covers, or if using modules, re-attach them. See [Using EMPOWER modules, page 63](#).

Attaching the handstrap

Attach the handstrap to the left or the right side of the device, according to your personal preference. To ensure a good fit:

1. Thread one end of the handstrap ribbon through the top handstrap slot; thread from the center of the device toward the top of the device.
2. Pull the end of the ribbon back towards the center of the handstrap and feed it up, over, and down through the lock buckle on the handstrap and pull it tight.
3. Thread the ribbon at the other end of the handstrap through the bottom handstrap slot; thread from the center of the device toward the bottom of the device.
4. Pull the end of the ribbon back towards the center of the handstrap and feed it up, over, and down through the lock buckle on the handstrap and pull it as tight as is comfortable for your hand.

If required, use a small blunt tool to push the ribbons through the handstrap slots on the device. Do not use a sharp tool.

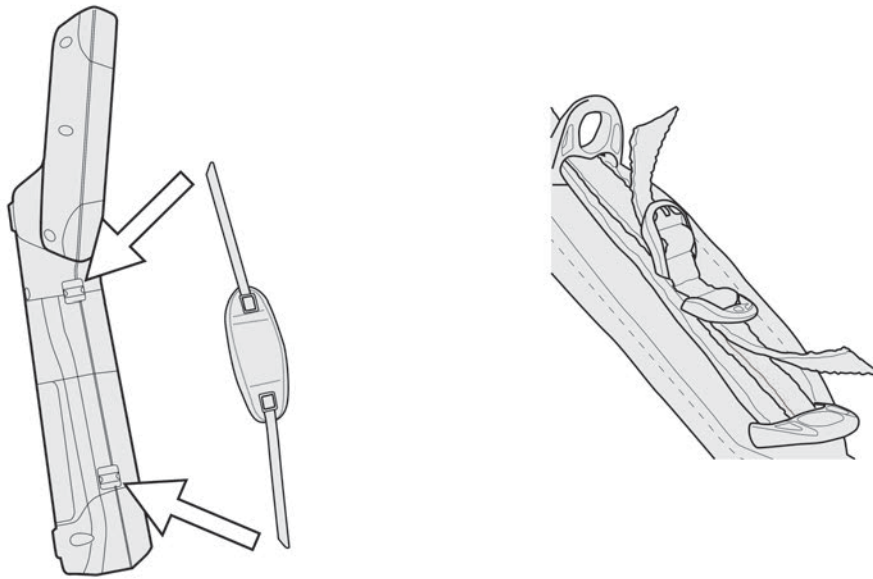

When using the handstrap, the device should sit firmly in the hand.

Tethering the stylus

Attach the stylus to the device to prevent accidentally dropping the stylus. The stylus is supplied with one end of the tether cord pre-looped to the stylus. You can attach the stylus to the left or the right side of the device. To tether the stylus to the device:

1. Take the loose end of the tether cord and push it through the tether point.
2. Feed the stylus through the loop and pull tight.
3. Place the stylus in the stylus dock to store it when not in use (top left corner as in image below).

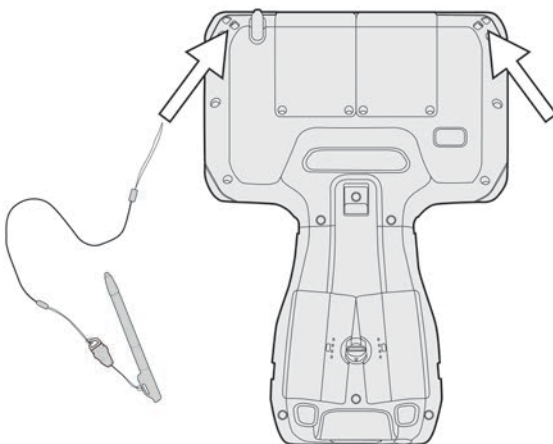

Installing a screen protector

The Ranger 7 data collector is fitted with a chemically strengthened glass touchscreen which is highly resistant to abrasion and impact damage. However to ensure maximum protection, it is recommended that you use a Spectra Precision-approved toughened glass Ranger 7 data collector screen protector.

To install a screen protector:

1. Place the device on a clean, flat surface. Make sure your hands are clean.
2. Clean the touchscreen with the supplied alcohol wipe.

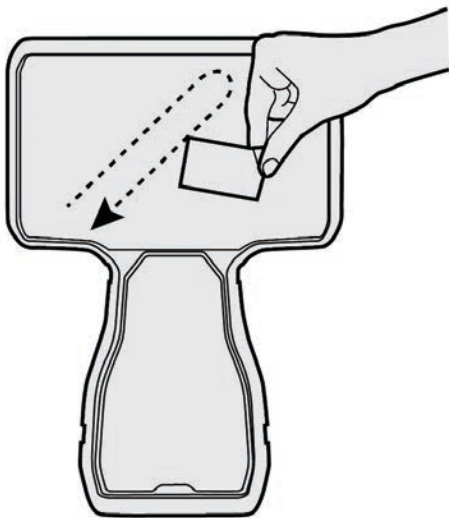

3. Polish and dry the screen with the lint-free cleaning cloth supplied.

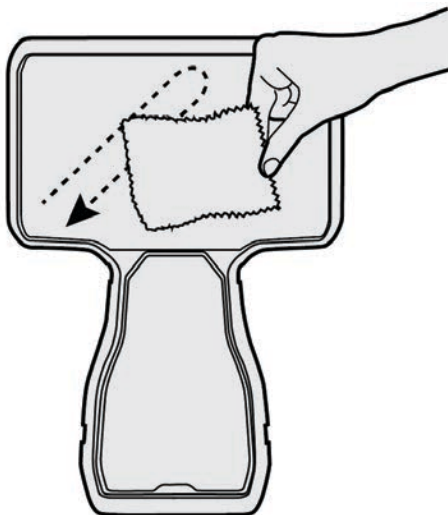

4. Remove any dust specs with the supplied dust sticker.

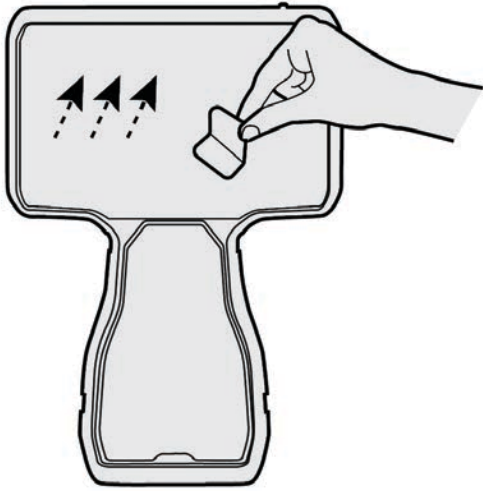

5. Remove the protective film from the screen protector.

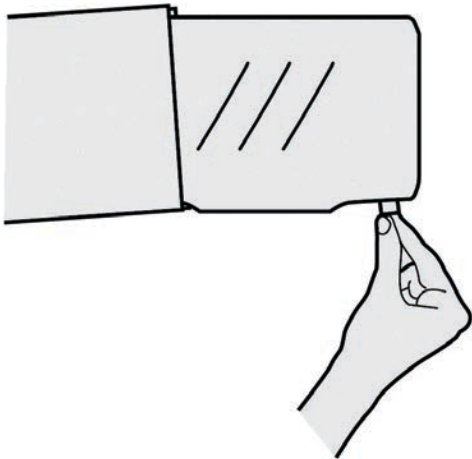

6. Align the screen protector with the top of the glass display.

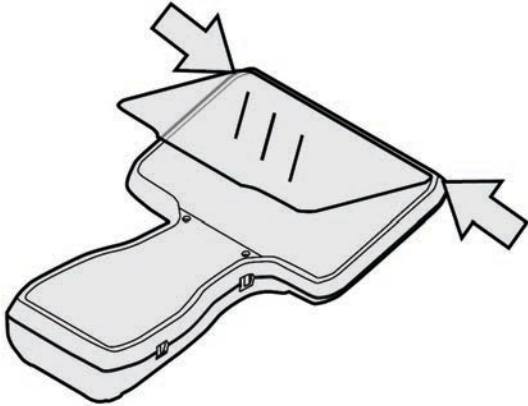

7. Carefully lay the screen protector down on the screen. If you make a mistake and the glass looks off-center, you can gently lift the screen protector up and realign it. Then, once the protector is on the screen, give it a soft press in the center and allow the adhesive surface to grip to the screen naturally.

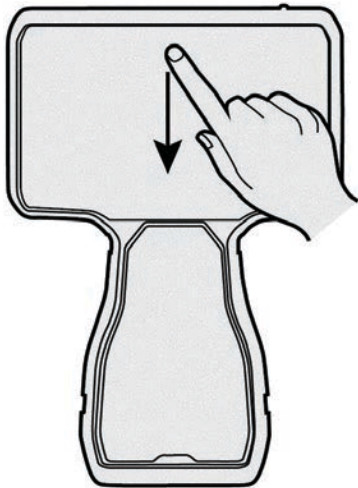

TIP – You can place the screen protector in place and fix it on the upper side with adhesive strips to the housing. This will keep the screen protector aligned when sticking in on.

8. If there are any bubbles remaining, use the cloth provided to gently smooth them toward the edges of the screen protector.

For more information on where to purchase the correct screen protector for your device, contact your local Spectra Precision reseller.

Installing and removing the batteries

The batteries in the Ranger 7 data collector can be charged inside the device, or using the Battery charger accessory (part number 121343-01-1).

The batteries in the Ranger 7 data collector are also hot swappable; you can remove one battery while the Ranger 7 data collector is still running on the second battery, and replace it with a freshly charged battery without shutting down or needing to restart the device.

⚠ CAUTION – If you remove both batteries, the device will shut down and work may be lost.

Installing the batteries

1. Turn the battery latch 90° clockwise or anticlockwise until the flat edge aligns with a battery opening.

NOTE – You can use a coin or the top of the stylus to do this.

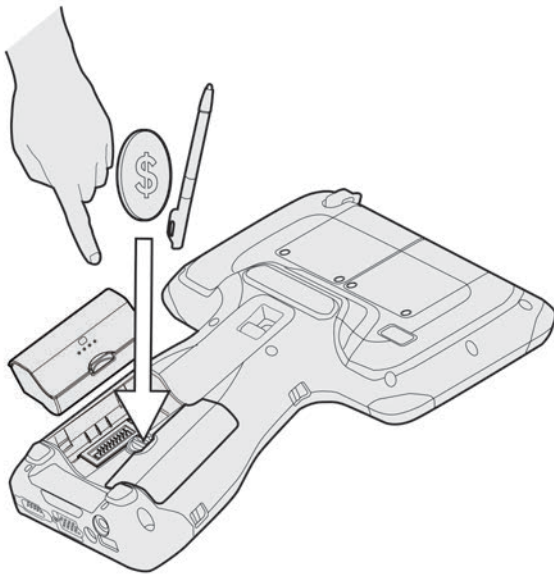

2. Insert a battery, then turn the battery latch 180° until the flat edge aligns with the second battery opening.
3. Insert a second battery.
4. Turn the battery latch 90° back to the center position to lock both batteries in place.

Removing / hot-swapping a battery

 **CAUTION** – Spectra Precision strongly recommends that before you hot swap a battery, you save your data.

 **CAUTION** – If you remove both batteries at the same time the device will instantly turn off due to power loss. Make sure you keep one battery in the device.

If you have the device turned off you can remove both batteries at the same time.

To hot-swap the batteries, replace one battery at a time:

1. Check the charge level of the batteries by pressing the button on each battery (see [Checking the battery level, page 33](#)).
2. Replace the battery with the lowest charge first; turn the battery latch 90° until the flat edge aligns with a battery opening, then remove the battery.
3. Replace this battery with a fully charged battery.
4. Turn the battery latch by 180° until the flat edge aligns with the second battery opening, then remove the second battery.
5. Replace the second battery, then turn the battery latch 90° back to the center position to lock both batteries in place.

Charging and power modes

It takes approximately 3 hours to charge the Ranger 7 data collector battery from an empty state. It may take longer if you are using your device for power-intensive activities, for example using GNSS or processing a lot of data while you are charging it.

Charging the battery

1. Connect the appropriate international plug adapter for your region to the AC adapter.
2. Connect the power cord to the charging port on the device.
3. Plug the power supply into an electrical outlet.





Checking the battery level

You can check the battery level:

- on the Lock screen. When you wake the device, the battery status appears in the lower-right corner of the Lock screen.





- on the Desktop taskbar. The battery status appears on the right side of the taskbar. Tap the battery icon for information about the charging and battery status, including the charge percent remaining.
- on the battery. Press the button on the battery to check the battery charge level. You can check the charge level of the battery in this way when the battery is inserted in the device, or when it is not.

The LEDs on the battery will show one of the following:

-  = No LEDs are lit: < 4 %
-  = 25 %
-  = 50 %
-  = 75 %
-  = All LEDs are lit: 100 %

LED charging status

The charging status is shown with an LED on the front top left corner of the display.

-  Red: charging error. It can take the device approximately 30 seconds to recognize a bad battery and indicate a charging error.
-  Orange: Ranger 7 data collector is charging.
-  Green: Ranger 7 data collector is fully charged.
-  Green - Flashing: Ranger 7 data collector is in Sleep state.

Turning the device on

To turn on the device, press the **Power** key. The Spectra Precision logo appears. Swipe up on the touchscreen to enter a PIN or password.

Saving battery power

To save battery power, set the screen to turn off when you haven't used it for a length of time. This state enables your device to resume quickly when you want to start working again.

To further save battery power, set the device to go into Sleep state when you haven't used it for a length of time. Sleep state saves your work and turns off the device. When you start up the device again, you are back where you left off.

To set the screen turn-off time and the Sleep state time, go to **Settings / System / Power & sleep**.

Wake and unlock

To wake the screen when it has turned off, press any key or swipe the screen.

To wake your device from Sleep state, press any key. After waking your device, to unlock it:

1. Swipe up from the bottom edge of the screen or press a key.
2. At the sign-in screen, enter your password or PIN.

Restart the device

To restart your device, tap **Start**  / **Power** / **Restart**.

Turning off the device

To turn off the device, tap **Start**  / **Power** / **Shut down**.

For information on customizing power management features, see [Power options, page 35](#).

Power options

The Windows 10 Pro operating system comes with pre-defined power options (Balanced, Power Saver, and High Performance). To access Power Options:

1. On the Desktop, tap the **Battery icon** in the **Notifications** bar at the bottom right of the screen, then tap **Power & sleep settings**.
2. Make sure **Power & sleep** is selected in the list on the left, then under **Related settings**, tap **Additional power settings**.

By default, the device is in **Balanced** mode.

Making your battery last longer

Following are some practical suggestions that you can do to maximize the operating time of the battery:

- Enable Power Management, and choose a power plan that saves power. A power plan is a collection of hardware and system settings that control how the device manages power.
- Decrease the display brightness to the lowest comfortable level (press **Fn + 4**).
- Shorten the length of time before the operating system turns off the display.
- Change your Sync settings. Go to **Settings / Accounts / Sync your settings** and deselect any items that do not need to sync across your Windows devices.

- If you use a USB flash drive, unplug it when you are not using it. Many USB devices use power just by being connected.
- Turn off the wireless radios when you are not using them. See [Using wireless networks, page 56](#).
- Turn off EMPOWER modules if you will not be using them for a prolonged period. See [Using EMPOWER modules, page 63](#).
- Turn off the screen rotation. See [Display settings: rotation lock, page 55](#)
- Turn off the device when you are not using it.



For more information on making your battery charge last longer, refer to the help topic on *Battery Saving tips on the Windows 10* support site on www.microsoft.com.





Using the touchscreen

Your Ranger 7 data collector can be easily operated with the touchscreen (using your fingers, a stylus, or a glove), an onscreen keypad, or the full built-in keypad.

Use the **Touch Control** app on the device to select or switch between any of the touchscreen input methods.

The table below describes the main touchscreen input gestures and functions supported on this device.

<p>Tap</p> 	<p>Tap once on something.</p>	<p>Opens/executes the action of what you tap on. To enter text, tap where you want to type; the onscreen keypad displays.</p>
<p>Press and hold</p> 	<p>Press and hold your finger or the Digital Pen down for a few seconds.</p>	<p>Shows a menu with options related to what you're doing (like right-clicking with a mouse). On the pop-up menu that appears, tap the action you want to perform.</p>
<p>Double-tap</p> 	<p>Double-tap on something.</p>	<p>Tap quickly twice on a webpage, map, or other screen to zoom. Double-tapping after pinching to zoom in some apps, such as Browser, reflows a column of text to fit the width of the screen.</p>

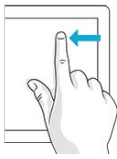
<p>Slide / swipe</p> 	<p>Slide / swipe your finger or the Digital Pen across the screen.</p>	<p>Scrolls through what's on the screen. Quickly move your finger across the surface of the screen, without pausing when you first touch it, to scroll a page or a list up or down. Scrolls vertically or horizontally.</p>
<p>Drag</p> 	<p>Drag your finger or the Digital Pen across the screen.</p>	<p>Hold your finger or the Digital Pen on an item for a moment and then, without lifting your finger/the Digital Pen, move across the screen until you reach the target position.</p> <ul style="list-style-type: none"> • Drag in a list to select multiple items. • Drag items on the screen to reposition them.
<p>Pinch / stretch</p> 	<p>Pinch your thumb and forefinger together or move them apart.</p>	<p>Zooms in or out of a website, map, or picture.</p>
<p>Rotate</p> 	<p>Put two or more fingers on an item and then turn your hand.</p>	
<p>Swipe from edge</p> 	<p>Swipe in from an edge of the screen.</p>	<ul style="list-style-type: none"> • Left edge swipe. Displays the Task View, the universal task-switching interface. See Using Task View and virtual desktops, page 53 • Right edge swipe. Displays the Action Center. See Using the Action Center, page 52. • Top edge swipe. Displays the Notification bar. • Bottom edge swipe. Displays the taskbar when the currently-running app is displayed full screen.

Using the onscreen keypad

You can type on the device using the touchscreen keypad. To access the onscreen keypad, tap in a text field, or tap the keypad icon in the taskbar. To hide the keypad, tap anywhere out of the text field, or tap the keypad icon again.

Using the stylus

Launch the **Touch Control** app to switch between **Finger**, **Glove**, and **Stylus** mode.

Take notes, draw, navigate, and mark up documents in your apps using the stylus that comes with your device. To make a selection, tap the screen once on the item you want to select. To display a right-click menu, tap and hold an item on the screen, then tap the required menu item.

NOTE – *Spectra Precision recommends that you use the Spectra Precision Ranger 7 data collector stylus accessory. There are many other capacitive touch styli available that will work with the Ranger 7 data collector as long as they have a rubber tip; however the stylus available as an accessory is tuned for the Ranger 7 data collector display and it fits into the stylus holder. Spectra Precision offers no guarantee that other styli will work.*

Using the keypad

The Ranger 7 data collector has a full physical QWERTY or ABCD keypad. You can configure some keypad behaviors using the Built-in Keyboard Settings utility. See [Configuring built-in keypad settings, page 42](#).

 **CAUTION** – When you first set up the device, make sure you select English US (Eng US) as the keypad language, independent of the keypad layout (ABCD or QWERTY) and the language you use on the Ranger 7 data collector.

Key items on the keypad are shown below:

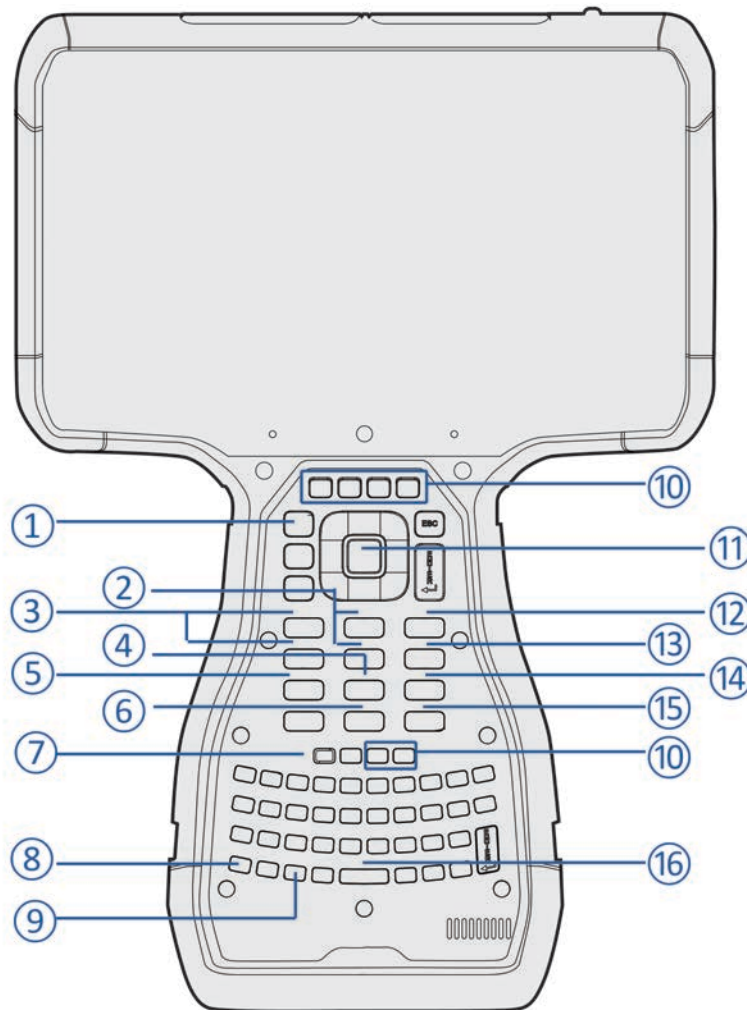

- 1 App menu. App-specific, this launches the menu for the active app.
- 2 Volume keys (Fn+8 Volume up; Fn+5 Volume down). Use to adjust the device's speaker volume.
- 3 Display brightness (Fn+7 Brighter; Fn+4 Dimmer). Adjust the display backlight brightness.
NOTE – You can also set the display brightness to adjust automatically when the ambient lighting conditions change. See [Display settings: adjusting the backlight](#), page 54
- 4 Keypad lock (Fn+2). Use to temporarily disable the keypad. This is a toggle function; the first press locks the keypad, the second press unlocks the keypad.
When the keypad is locked, a message shows briefly on the display and the keypad

locked icon  displays on the taskbar. Note that this icon is not pinned to the taskbar by default. You can pin the icon to the taskbar to make it always visible when the keypad is locked; see [Pinning keypad status icons to the Taskbar, page 45](#) for more information.

- 5 Touchscreen lock (Fn+1). Use to temporarily disable the touchscreen, for example to clean the display. This is a toggle function; the first press locks the touchscreen, the second press unlocks the touchscreen.

When the touchscreen is locked, a message shows briefly on the display and the touchscreen locked icon  displays on the taskbar. Note that this icon is not pinned to the taskbar by default. You can pin the icon to the taskbar to make it always visible when the touchscreen is locked; see [Pinning keypad status icons to the Taskbar, page 45](#) for for for more information.

- 6 Print screen (Fn+0). Print all or part of the screen to the clipboard.

NOTE – Press the Windows key + Fn + 0 to save a screen capture to the My Pictures / Screenshots folder.

- 7 Power key. Turn the device On / Off.

- 8 Fn Function key. Use the Fn key to access a key's alternate function, as printed in yellow above the key; press and hold the Fn key and press the other key.

If **Sticky keys** is enabled you do not need to hold the **Fn** key while pressing the other key. For more information see [Sticky Keys, page 43](#).

- 9 Windows key

- 10 Functions keys. Six keys, 12 functions.

TIP – These can be configured in your Spectra Precision software according to your requirements. Refer to the software documentation.

- 11 Numeric keypad **Enter** key.

- 12 Camera (Fn+9). Launches the Camera app

- 13 Airplane mode (Fn+6). Press to turn Airplane mode On or Off. A message shows briefly on the display.

- 14 Sleep mode (Fn+3). Use to place the device in Sleep mode.

NOTE – To wake the device from Sleep mode, you must press the Power key.

- 15 Num Lock (Fn+. - Decimal). Use to lock the Numeric keypad in Num state, or cursor Navigation state. In Navigation state, the keys will function according to the key+Shift behavior (Home; End; Page up; Page Down; left, right, up, or down arrow;

Insert; and Delete.) When Num lock is on (the Numeric keypad is locked in Num state) the status icon  shows in the taskbar.

NOTE – The "A" part of this status icon indicates if CAPS lock is on or off. See [Status icons in the taskbar, page 45](#).

NOTE – As on a standard PC keyboard, the Shift key can be used to temporarily invert the Num lock state.

- 16 SYM key (Fn+Space bar key). Use to enter special symbols and accented characters that are not present on the keypad. See [Using SYM Key IME, page 46](#) for more details.

Modifier keys and Sticky keys

The modifier (or shift) keys are keys that modify the action taken when other keys are pressed while the modifier key is held down. Modifier keys can be used in combinations with more than one pressed at the same time. The modifier keys are:

- the **Shift** key
- the **Fn** key
- the **Ctrl** key
- the **Windows** key
- the **Alt** key

To make the keypad easier to use, you can configure the modifier keys as **Sticky Keys**. When enabled, the modifier keys “stick down” when pressed so that they do not have to be held while the other key is pressed.

Because the device is normally hand-held, it can be difficult to press multiple keys on the built-in keypad at the same time.

The modifier keys—**Shift**, **Fn**, **Ctrl**, **Windows**, and **Alt**—are normally used in combination with other keys. To make these keys easier to use, you can configure them to work **Sticky Keys** mode.

This means that the keys “stick down” when pressed allowing multiple key combinations to be pressed by pressing the keys sequentially. For example, the **Ctrl+Alt+Del** combination can be entered as press and release **Ctrl**, press and release **Alt**, and press and release **Del** requiring only one finger to do what normally would require three.

Sticky Keys is on by default. For information on configuring Sticky Keys behavior, see [Sticky Keys, page 43](#).







The different **Sticky Keys** modes are:

Mode	Modifier Key Behavior
Sticky Keys Disabled	All modifier keys must be pressed and held to access modified key functions. For instance the Shift key must be pressed and held while and alpha key is pressed to access capital letters.
Normal Sticky Keys Mode	Pressing and releasing a modifier key one time latches the modifier key state down until another non-modifier key is pressed and which point the modifier key is released.
Lock Sticky Keys Mode	Pressing and releasing a modifier key one time latches the modifier key state down until another non-modifier key is pressed and which point the modifier key is released. Pressing and releasing a modifier two times in a row locks the modifier key state down until it is pressed and released a third time.

To make it easier to determine the locked state of the modifier keys, feedback is provided:

- Audible. A sound is played when a modifier key is locked down or unlocked
- Visible. A taskbar icon is displayed.

The taskbar icon is divided into 5 segments. Each segment represents the sticky state of one of the 5 modifier keys. The segments are organized in the same orientation as the keys on the keypad. The different **Sticky keys** icons are:

-  indicates that none of the modifier keys are "sticky" down.
-  indicates that the **Shift** key is "sticky" down.
-  indicates that the **Fn** key is "sticky" down.
-  indicates that the **Ctrl** key is "sticky" down.
-  indicates that the **Windows** key is "sticky" down.
-  indicates that the **Alt** key is "stick" down.

Configuring built-in keypad settings

Use the Built-in Keypad utility to change the behavior of some of the built-in keypad features.

1. Tap , scroll down and expand **Windows System**, then tap **Control Panel**.

***NOTE** – In Tablet mode, tap  then tap the All Applications icon to show the list of applications.*

2. In **Category** view, select **Hardware and Sound**, or **Ease of Access**.
3. Tap **Built-in Keyboard** or one of the subcategories in blue to open the settings applet to a specific page.

The Built-in Keyboard utility has four options:

- [Sticky Keys, page 43](#)
- [Backlight, page 44](#)
- [Status Icons, page 44](#)
- [SYM Key, page 44](#)

It also has an **About** page which shows the Built-in keypad utility version, the version of the keypad's firmware, and the identifier for the type of built-in keypad installed.

To use the utility:

- Select the option you want to configure settings for by tapping it. Details for the options are covered below.
- Click **Apply** or **Ok** to commit any changes to the settings. **Ok** also closes the utility.
- To close the utility without committing the last uncommitted changes, click **Cancel** button.

Sticky Keys

To enable **Sticky Keys** behavior if it has been turned off, select **Turn on Sticky Keys**. The options here are:

- **Include Windows key as sticky key.** Because the **Windows** key is used as a non-modifier key to open the Windows Start menu, you can make it non-sticky by deselecting **Include Windows key as sticky key**. The **Windows** key as a sticky key is disabled by default.
- **Lock Modifier keys when pressed twice in a row.** You can set a modifier key to be locked down indefinitely by setting **Lock Modifier keys when pressed twice in a row**; when you then press a modifier key twice, it locks down until you press the key a third time. This is deselected by default.
- **Play a sound when modifier keys are pressed.** Plays a sound when sticky keys are locked down or released. This is set by default.

- **Display the Sticky Keys icon on the taskbar.** Select this option to show the sticky keys icon on the taskbar. This is set by default.
- If you need to use the Windows supplied **Ease of Access** sticky keys function, because you need it for an external keyboard, you may want to disable the Built-in keypad's sticky keys feature for the **Windows, Shift, Ctrl,** and **Alt** keys because the two features conflict with each other. In this case set **Use Windows Sticky Keys for standard modifier keys (Shift, Ctrl, Alt, and Windows).** This is deselected by default.

Backlight

The built-in keypad may be equipped with a backlight that makes the keypad easier to use in dimly lit areas. The backlight is activated when a key is pressed, stays on for a while, and then turns off to conserve power. The backlight can be disabled and the brightness adjusted. The system ambient light sensor can also be used to keep the backlight from turning on in well lit areas.

NOTE – *If the keypad does not have a backlight, you won't see the Backlight option.*

- The backlight is enabled by default.
- If you don't work in low light settings, you can disable the keypad backlight to save power. Clear the **Enable Keyboard backlight** to completely disable the backlight.
- Set the **Timeout** value to determine how long the backlight stays on when no keys are being pressed.
- Select **Automatically disable the keyboard backlight in well lit areas** to prevent the backlight from turning on if you are in a well lit area. This is selected by default.
- Move the **Set keyboard backlight brightness** slider to control how bright the backlight is; slide right for brighter, and left for dimmer. Brighter settings consume more power than dimmer settings.

Status Icons

Use the **Status Icons** option to show or hide the **Caps Lock/Num Lock** icon on the taskbar. **Show Caps Lock & Num Lock status on the taskbar** is selected by default.

SYM Key

The **SYM Key** option allows you to turn the SYM Key input method on or off. When enabled the **SYM Key input method** allows you to easily enter certain accented characters and special symbols. See [Using SYM Key IME, page 46](#) for details on its usage.





If **SYM Key input method** is not enable, when you press the **SYM** key (Fn + spacebar), this **SYM Key settings** page displays.

Note that enabling and disabling the SYM Key input method requires administrator privileges and must be done for both 32 bit and 64 bit applications. Because of this requirement you will be prompted for your approval twice and possibly prompted for administrator credentials. Enter your password if necessary and tap **Yes** for both instances.

Status icons in the taskbar

Because the keypad lack Caps lock (alpha keys) and Num lock (number pad) indicators, a taskbar icon is provided that displays the **Caps Lock** and **Num Lock** states.

The icons for different Caps and Num lock states are :

-  Caps and Num unlocked. Lowercase alphabet letters are produced and the number pad does the cursor movement functions.
-  Caps locked and Num unlocked. Uppercase alphabet letters are produced and the number pad does the cursor movement functions.
-  Caps unlocked and Num locked. Lowercase alphabet letters are produced and the number pad does number functions.
-  Caps and Num locked. Uppercase alphabet letters are produced and the number pad does number functions.

NOTE – As on a standard PC keyboard, the Shift key can be used to temporarily invert the Caps and Num lock states.

You can set these icons to show or not show in the taskbar.

Pinning keypad status icons to the Taskbar

Because the Sticky keys, Caps Lock/Num Lock, Touchscreen Disable, and Keypad Disable icons show real time information about the state of the keypad, you may want to pin them to the taskbar. If you don't see both icons and they are enabled in the Built-in Keyboard Settings utility you can find them by tapping on the ^ symbol at the left side of the taskbar icons area.

To “pin” an icon to the taskbar, tap-hold on the icon in the popup window you want to pin, then drag it to the taskbar.

To “unpin” icons, tap-hold on the icon in the taskbar and drag it to the popup window.

Using SYM Key IME

The **SYM** key is a hotkey that is used to invoke the Symbol IME (Input Method Editor). Use the Symbol IME to enter accented character and other special symbols.

This option is disabled by default. To enable it, open the **Built-In Keyboard settings** utility and select the **Sym Key** option. See [Configuring built-in keypad settings, page 42](#)

If the SYM Key IME is not enabled when you press the **SYM** key (**Fn+ Space bar**), a warning message displays. Tap the message to open the **Built-In Keyboard settings** utility.

Selected Input Method Indicator

The Windows 10 operating system shows which input method is selected in one of several ways depending on whether the language bar is enabled, and the state of the language bar.

- If the language bar is disabled (the default) the selected input method is indicated on the taskbar:

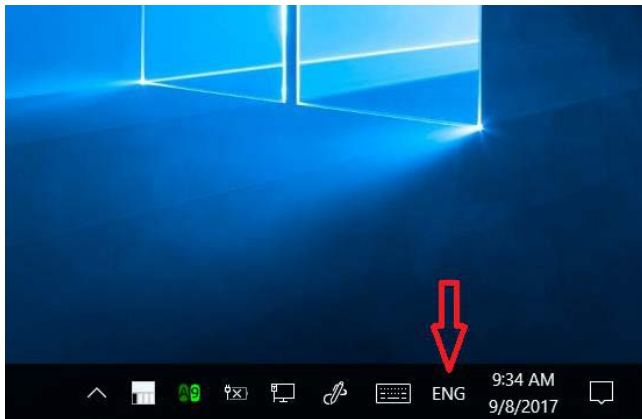

- If the language bar is enabled and maximized, the selected input method is indicated on the language bar at the top of the screen:



- If the language bar is enabled and minimized, the selected input method is indicated

on the minimized language bar in the taskbar:



Selecting the SYM Key IME

The SYM Key IME can be selected as the active input method by one of the following methods:

- Repeatedly pressing the **Windows+Space bar** hotkey combination until the SYM Key IME is selected.
- If the language bar is disabled, clicking on the input method icon on the taskbar and selecting the SYM Key IME from the popup menu:



- If the language bar is enabled and maximized, clicking on the input method selector and selecting the SYM Key IME from the dropdown menu:



- If the language bar is enabled and minimized to the taskbar, clicking on the input method selector and selecting the SYM Key IME from the popup menu:



Using the SYM Key IME

When you type, the SYM Key IME highlights characters that have accented versions or alternate symbols (that is, different currency or punctuation symbols). The SYM Key IME works in one of two modes:

- **Inline Mode.** In Inline mode, characters that have alternates are highlighted as you type. When a character is highlighted, press the **SYM** key (**Fn+Space bar**) to change the character to the next available character in the list of possible characters. Repeatedly press the **SYM** key until the desired character is shown, and then continue typing normally. To accept a highlighted character, press **Enter**.

For example, to type **fenêtre**:

- Type **fen**e; the first **e** and the **n** are highlighted and then the second **e** is highlighted.
- Press **Fn+Space bar (SYM)** three times to select the **ê** character.
- Type **tre**.
- Press **Enter** to accept the final **e**.

- **Popup Mode.** In Popup mode, characters that have alternates are highlighted as you type and a popup window of the list of alternate characters is shown. When a character is highlighted, press the **SYM** key (**Fn+Space bar**) to change the character to the next available character in the list of possible characters. To select the character you want to use from the popup window, do one of the following:
 - Repeatedly press the **SYM** key until the desired character is highlighted in the popup window.
 - Use the cursor keys to select a character from the popup window.
 - Press the number key associated with the desired character in the popup window.
 - Tap the desired character in the popup window.

When the popup window is open, you can select the currently highlighted character and close the popup window in the following ways:

- Press **Enter**.
- Continue to type characters other than the cursor movement keys.

You can also press the Escape key (**ESC**) to close the popup window; this deletes the character being input.

For example, to type **fenêtre**:

- Type **fen**; ignore the popups that appear for the first **e** and the **n**. The second **e** is highlighted, with a popup window.
- Press **Fn+Space bar (SYM)** three times to highlight the **ê** character.
- Type **t**; the **ê** character is accepted.
- Then type **re**. A popup remains open.
- Press **Enter** to close the final popup.

Switching Modes

There are two ways to switch between inline and popup modes.

- Press the **Ctrl+Space bar** key combination.
- Tap the mode button on the language bar.
 - If the language bar is maximized this is at the top of the screen.
 - If the language bar is minimized, this is at the bottom of the screen

Application Support for SYM IME

SYM IME only works with applications which support Text Services Framework (TFS).

For information about adding TFS support to your application, go to:

[https://msdn.microsoft.com/en-us/library/windows/desktop/ms629032\(v=vs.85\).aspx](https://msdn.microsoft.com/en-us/library/windows/desktop/ms629032(v=vs.85).aspx)

SYM IME issues and limitations

The following are known issues and limitation with version 1.0.3 of SYM IME:

- Edit Controls.
 - If a composition is active, a character is highlighted by SYM IME for editing, and you mouse-click or tap somewhere else in the text of the edit control, the composition highlighted character is moved to the location of the mouse-click / tap. This is usually not what you intended. To avoid this, press **Enter** to close the composition before you click or tap at the new location.
- ComboBox Controls.
 - If a composition is active when leaving a ComboBox control then the highlighted character is moved to the beginning of the string. For example, if you type **abc** into a ComboBox control and then click on another control, the typed string changes to **cab** if the **c** was still highlighted. To avoid this, press **Enter** to end the composition before you click on another control.
 - The ComboBox drop listbox can interfere with the SYM IME popup window. Sometimes the list box will be on top and sometimes the popup window will be on top.



Using the Windows 10 operating system

- ▶ Using accounts
- ▶ Using the Start menu
- ▶ Using the Action Center
- ▶ Using the Windows Mobility Center
- ▶ Using Task View and virtual desktops
- ▶ Settings

This section introduces some basic information on using the Windows 10 Pro operating system on your Ranger 7 data collector. For comprehensive information, go to [Get Started with Windows 10](http://windows.microsoft.com) on <http://windows.microsoft.com>.

Using accounts

When you set up your Ranger 7 data collector, an account is set up for you. You can create additional accounts later for each user of the device, so that each person using the device can have their own settings.

To set up additional accounts and to change account settings, tap , then tap the quick-access Accounts icon . Or, go to  / **Settings** / **Accounts**.

Sign in

1. Press the Power button to turn on or wake the Ranger 7 data collector.
2. Swipe up on the screen.
3. If there are multiple accounts set up on the device, select your account from the list. Tap **Sign in** and enter your password (if one has been set).

Sign out

Tap-hold , and tap **Shutdown or sign out**, then tap **Sign out**.

Using the Start menu

Tap  open the **Start** menu.

At the lower left of the **Start** menu, you'll find quick links to **Account** settings, all other **Settings**, and **Power** (shut down, sleep, and restart).

The apps you've used most often appear at the top of the **Start** menu.

Tiles on **Start** act as quick links to apps. You can rearrange, resize, add, and remove tiles whenever you want. To add an app tile, tap-hold it in the **Start** menu and drag-drop it to the **Tiles** area. For more information, see [Organize your apps](http://windows.microsoft.com) on <http://windows.microsoft.com>.

Using the Action Center

Swipe in from the right edge of the screen or tap **Action Center**  on the taskbar to open the Action Center. Examples of what you can use the Action Center for include:

- viewing notifications
- adjusting common settings like Wi-Fi connections or screen brightness
- creating a wireless connection to other devices

For more info, see [Find your notifications](http://windows.microsoft.com) on <http://windows.microsoft.com>.

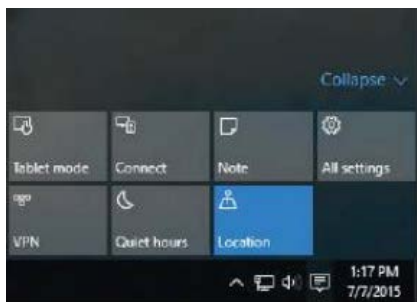

Using the Windows Mobility Center

Tap-hold , and tap **Mobility Center**. Use the Mobility Center to, for example:

- view device information
- adjust common settings such as screen brightness, screen rotation, and volume
- manage Wi-Fi and Bluetooth connections

Using Task View and virtual desktops

Task View allows you to quickly hide all windows and show the desktop, find an open window, and manage windows across multiple "virtual desktops".

Swipe in from the left edge of the screen or tap **Task View** on the taskbar to display all open windows, access any virtual desktops you have set so you can switch between them, and add more virtual desktops if you need to.

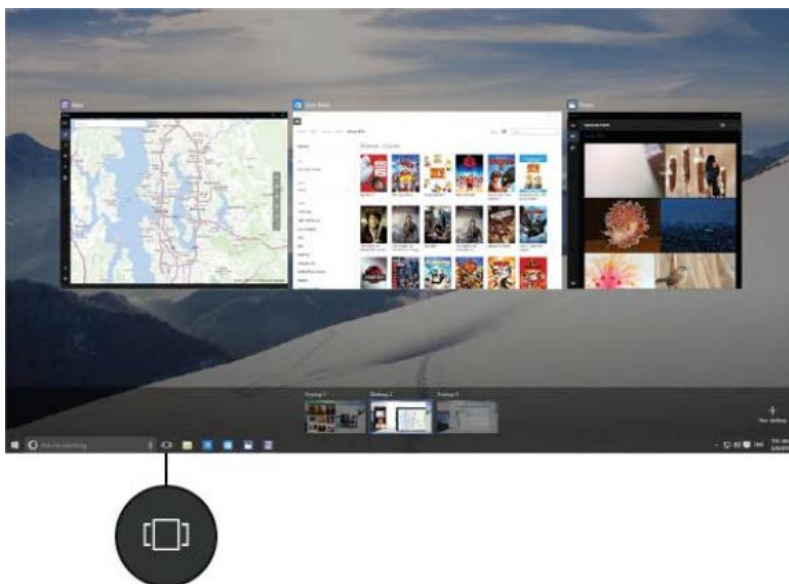

Settings

Tap  / **Settings** for access to all your settings.

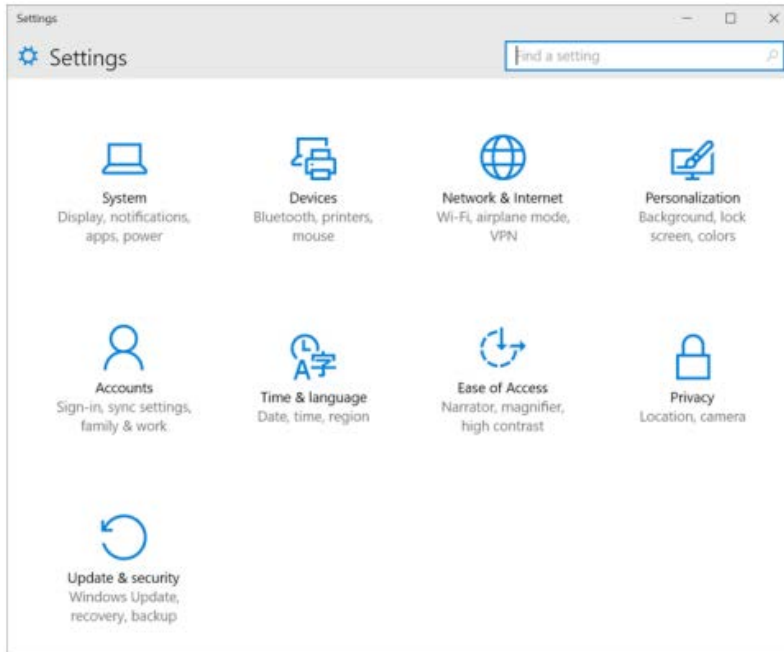

Display settings: adjusting the backlight

The Ranger 7 data collector is equipped with a high brightness outdoor readable display. You can easily increase the brightness of the display to increase the readability of the device in bright sunlight conditions, or turn down the brightness to help conserve battery power when working indoors or in dull conditions. You can also have the device automatically adjust the backlight power depending on the ambient light conditions.

To set the backlight to adjust automatically:

1. Tap  / **Settings** / **System** / **Display**.
2. Turn the automatic adjustment on or off using the toggle switch.

To quickly adjust the backlight, use the Display brightness keys on the keypad:

- Press Fn+7 to increase the display brightness
- Press Fn+4 to decrease the display brightness

Alternatively:

1. Swipe in from the right edge of the screen or tap **Action center**  on the taskbar to open the Action center, then expand the quick-access icons if they are collapsed.

2. Tap the brightness icon  to adjust the display brightness setting.
 - If the backlight is not set to adjust automatically, the backlight cycles between 0%, 25%, 50%, and 100% power.
 - If the backlight is set to adjust automatically, the backlight cycles between Darkest, Darker, Suggested, Brighter, and Brightest.

Tap until you reach the backlight level that best suits your conditions.

You can also manually adjust the backlight setting from the **Display** dialog:

1. Tap  / **Settings** / **System** / **Display**.
2. Use the brightness level slider to fine tune the display brightness level.

Display settings: rotation lock

The Ranger 7 data collector is equipped with orientation sensors that can detect if your device is in portrait or landscape orientation. The operating system can automatically adjust the display to match your device orientation, or you can lock the orientation.

To adjust the automatic display orientation feature, swipe in from the right edge of the screen or tap **Action center**  on the taskbar to open the Action center, then select

rotation lock  to turn rotation lock on or off.

Using wireless networks

- ▶ Working with Wi-Fi networks
- ▶ Working with mobile broadband
- ▶ Airplane mode

The Ranger 7 data collector supports wireless connectivity; connect to wireless networks using the built-in Wi-Fi radio (also sometimes called Wireless LAN, WLAN, or 802.11), or the built-in mobile broadband data (also called Wireless WAN, WWAN, or cellular data) capability.

This section describes how to get online with your Ranger 7 data collector using these wireless networking capabilities.

Working with Wi-Fi networks

Using Wi-Fi you can connect to a wireless network and browse the Internet, download apps, send email messages, access online services, or access other computers and devices on your network.

Before you can send and receive data over Wi-Fi, you need to turn on Wi-Fi on your Ranger 7 data collector and connect to a wireless network.

Connecting to Wi-Fi

1. Tap the Wireless network icon  in the bottom-right corner of the screen. If it isn't showing, swipe in from the right side of the screen to open the Action Center, then tap **Network**.
A list of available wireless networks appears.
2. Select the Wi-Fi network you want to connect to.
3. Tap **Connect**. If prompted, enter your network security key (network password), and tap **Next**.

4. If prompted, choose whether you want to share with other computers and devices on the network. Select **No** if you are connecting to a network in a public place like a café.

You can check your connection by opening the browser and connecting to the Internet;

tap , and select **All Apps / Internet Explorer**. Some wireless networks may require you to enter a password in a browser window.

Disconnecting from a Wi-Fi network

1. Tap the Wireless network icon  in the bottom-right corner of the screen.
2. Select the network that has a **Connected** status.
3. Tap **Disconnect**.

Forgetting a Wi-Fi network

If you do not want your device to automatically connect to a saved Wi-Fi network, you can forget that network.

To forget a wireless network so it no longer appears in your list of networks:

1. Tap  / **Settings**.
2. Select **Network and Internet / Wi-Fi / Manage known networks**.
3. In the list of networks that appears under, tap the network you want to remove, and tap **Forget**.

Working with mobile broadband

The Ranger 7 data collector has an integrated cellular modem enabling you to connect to a mobile broadband network. The Ranger 7 data collector supports Worldwide LTE (where available), and is compatible with AT&T- and Verizon-certified 3G and 4G networks.

Before you can send and receive data over mobile broadband, you must have a MicroSIM card in the device (see [Inserting SD and SIM cards, page 26](#)). You must then turn on Cellular data on the Ranger 7 data collector and configure the connection.

Connecting to mobile broadband

1. Tap the Wireless network icon  in the bottom-right corner of the screen. If it isn't showing, swipe in from the right side of the screen to open the Action Center.
2. Tap **Cellular** to turn it on, then tap-and-hold it and tap **Go to Settings**. (Or, tap / **Settings / Network and Internet / Cellular**.)

3. If you want to connect to this network every time it's in range, select **Let Windows manage this connection**.
4. Select **Roam** or **Don't Roam**, as required. You might incur extra charges if you allow roaming.
5. Choose whether to use cellular instead of Wi-Fi when Wi-Fi is poor. Windows will switch automatically between Wi-Fi and cellular broadband as needed.

For more information, refer to the help topic on *Cellular settings in Windows 10* on the Windows 10 support site www.support.microsoft.com.

Locating the device's IMEI number

The IMEI number is a unique 15-digit number that identifies the cellular module installed on your device. Your mobile broadband operator may need to know the IMEI number of your device in order to register the device with the network and activate your mobile broadband data plan.

If your Ranger 7 data collector is mobile broadband enabled, the IMEI number will be printed on the serial number label under the battery.

Alternatively, to check the IMEI number in the operating system:



1. Tap **Settings / Network and Internet / Cellular**.
2. Select the Cellular module icon, then select **Advanced options**.
The cellular module properties (including the IMEI) are displayed in the **Properties** section.
3. To copy the IMEI number to the clipboard, tap **Copy**, then paste the text into your desired application (for example, Notepad, or the Email client) using the Paste command or the Ctrl+V keypad shortcut.

If you cannot find the IMEI number for your device, contact your reseller.

Airplane mode

If you are travelling on an airplane, or don't need to use wireless functions on the Ranger 7 data collector for a while, use Airplane mode to turn on or off all wireless radios with transmitting features built into the Ranger 7 data collector, including Bluetooth, Wi-Fi, Cellular LTE, or GNSS, as well as any wireless radios connected to the Ranger 7 data collector such as EMPOWER modules.

There are several ways to turn Airplane mode on or off:

- on the touchscreen, tap the Action center icon  on the taskbar, then select **Airplane mode** . If the icon is dimmed, Airplane mode is off.

- on the keypad, use the **Airplane mode** key = **Fn** key (lower left corner) and **6** on the numeric keypad.

Working with GNSS

The data collector has a built-in 2 to 4 meter accuracy GNSS (Global Navigation Satellite System) receiver module, and an integrated antenna with automatic SBAS corrections. The integrated receiver supports SBAS satellites under normal conditions.

The data collector supports most of the Spectra Precision GNSS receivers. If you want to connect via Bluetooth make sure your receiver is capable of using a Bluetooth PIN; older receivers may not connect due to the security expectations of the Windows 10 Professional operating system.

You cannot use an external antenna with the data collector's integrated GNSS receiver. For advanced GNSS setups, use a survey grade receiver.

You cannot postprocess GNSS data from the internal receiver. If you want raw GNSS data for postprocessing, use an external GNSS receiver.

Using the uBlox uCenter application

The uBlox uCenter app allows for more granular configuration settings of the GNSS receiver. If required, you can download it from the uBlox website.

Using accessories and connecting to other devices

- ▶ [Connecting to USB accessories](#)
- ▶ [Connecting to Bluetooth accessories](#)
- ▶ [Connecting to RS-232 peripherals](#)
- ▶ [Transferring data between your Ranger 7 data collector and another computer](#)
- ▶ [Using the pole mount](#)
- ▶ [Using the shoulder sling](#)
- ▶ [Using the desktop hub](#)

You can connect monitors, accessories, and other devices directly to your Ranger 7 data collector using USB or Bluetooth and RS-232. Some custom accessories can connect to the device through the proprietary docking connector.

Connecting to USB accessories

The Ranger 7 data collector has a USB port for connecting USB devices, such as a flash drive, scanner, or printer. The Ranger 7 data collector has built-in support for mass storage devices and human interface devices.

Other types of USB devices may require drivers.

To connect a USB device, plug the device cable into the USB A-type port on the bottom of the Ranger 7 data collector.

Connecting to Bluetooth accessories

The Ranger 7 data collector has embedded Bluetooth wireless technology—a short-range wireless communication technology that allows wireless data transfer and communication between devices over a distance of up to 10 meters (30 feet).

To pair the Ranger 7 data collector with a Bluetooth device, it must have a Bluetooth PIN. Some old Bluetooth devices do not require a PIN. For security, the Ranger 7 data collector cannot connect to these older devices that do not require a PIN.

NOTE – To connect to a Bluetooth-enabled receiver with a PIN, if for any reason you cannot connect via Bluetooth, connect over Wi-Fi to configure the receiver. The IP address is in most cases 192.168.142.1. Refer to the documentation for the receiver for details and receiver specific settings.

A Bluetooth icon shows in the taskbar when Bluetooth is turned on.

TIP – To save battery, turn off Bluetooth when you are not using it. Bluetooth is off when the device is in Airplane mode.

Before you can transfer data or communicate between your Ranger 7 data collector and another Bluetooth enabled device, you must pair the Ranger 7 data collector and the device.

To pair and connect a Bluetooth device with your Ranger 7 data collector:

1. Turn on the Bluetooth device and make it discoverable. To learn how to do this, check the documentation for your Bluetooth device or go to the manufacturer's website.
2. Tap  / **Settings** / **Devices** / **Bluetooth**.
3. Make sure the slider is set to On, then tap **Add Bluetooth or other device**, then tap **Bluetooth**. The Ranger 7 data collector searches for Bluetooth devices.
4. In the list of Bluetooth devices, tap the device you want to pair with your Ranger 7 data collector.
5. Follow the on-screen instructions to finish pairing your device.
6. If the other device requires a passcode (sometimes called a pairing code), you'll be prompted for it. If you don't know the passcode, check the information that came with your device or the manufacturer's website.

Connecting to RS-232 peripherals

If your Ranger 7 data collector is fitted with the RS-232 version of the I/O module, you can directly attach RS-232 peripheral devices with a null modem cable.

To connect an RS-232 device, plug the device cable into the port. Refer to the documentation for the RS-232 device for instructions on setting up and using the device.

Transferring data between your Ranger 7 data collector and another computer

Your Ranger 7 data collector is powered by the Windows 10 Pro operating system, and cannot connect directly to an office computer powered by a Windows operating system as a 'client' in the same way as a device with a mobile operating system can. You may still want to transfer data from your Ranger 7 data collector to another PC; there are a number of ways you can do this, including:

- Using cloud-based file sync services, such as Trimble Connect, [Dropbox](#), [Microsoft OneDrive](#), [Google Drive](#) over Wi-Fi or 4G
- Via Ethernet; see [Using the desktop hub, page 65](#)
- Via Wireless LAN; see [Working with Wi-Fi networks, page 56](#)
- USB memory stick; see [Connecting to USB accessories, page 61](#)

Using EMPOWER modules

EMPOWER modules can be used to extend or expand the basic capabilities of your device. Each EMPOWER module can be installed, removed, or moved from one EMPOWER-enabled device to another.

The Ranger 7 data collector allows up to two EMPOWER modules to be installed at a time.

For more information about using EMPOWER modules, refer to the module documentation available here: www.trimble.com/empowermodules.

Installing EMPOWER modules

1. Make sure your device is turned off. For more information, see [Charging and power modes, page 33](#).
2. Turn the device over, and using a Phillips #1 screwdriver, loosen the 2 screws on the EMPOWER module bay cover to remove it.

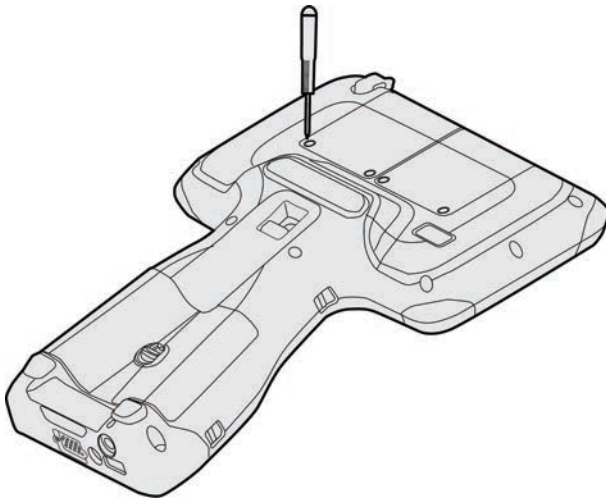

Store the EMPOWER module bay cover somewhere safe for potential future use.

NOTE – Before you remove a module from the device, make sure the device is powered off. Reattach the module bay cover when no module is attached.

3. Hook the EMPOWER module onto the device, ensuring that the slots on the top of the device line up with those on the EMPOWER module.
4. Tighten the 2 captive screws at the bottom of the EMPOWER module using a Phillips #1 screwdriver. Do not overtighten the screws.

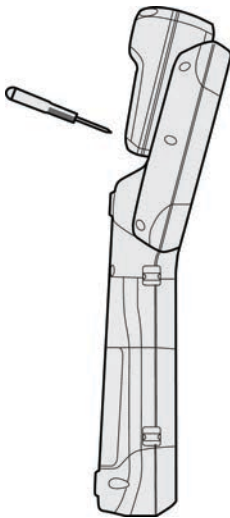

5. Turn on the device and start the EMPOWER Hub (found under Start / EMPOWER / EMPOWER Hub). The EMPOWER Hub is a centralized location for managing and monitoring your EMPOWER modules.

NOTE – Some modules may require that additional drivers and/or supporting applications be installed before the base device recognizes the module. These files can be downloaded from: www.trimble.com/empowermodules.

Using the pole mount

An optional accessory for the Ranger 7 data collector, the pole mount consists of two parts:

- the pole-facing part
- the Ranger 7 data collector-facing part.

The two parts are connected using a connector that is compatible with other Spectra Precision mounting products.

The pole-facing part is compact, so that it fits into a 10 cm (4") pipe for storage.

The Ranger 7 data collector-facing part has an arm which can be set up for left- or right-hand usage. To switch it from one side to the other, unscrew the black screws in the cradle plate where the device sits, rotate the cradle plate, then screw it back into place.

The Ranger 7 data collector “snaps” easily into the cradle. To use the Ranger 7 data collector on the pole mount, first sit the bottom of the Ranger 7 data collector into the hook at the bottom of the cradle, then push it firmly into the snap lock.

To remove the Ranger 7 data collector from the cradle, on the back of the locking mechanism pull the lever Ranger 7 data collector to release the device.

Using the shoulder sling

There are several ways to attach the shoulder sling to the Ranger 7 data collector:

- If you have a handstrap attached to the device (see [Attaching the handstrap, page 27](#)), clip the shoulder sling onto the handstrap buckles.
- If you do not have a handstrap attached to the device, attach the shoulder sling standalone connector straps to the handstrap slots on the device, and clip the shoulder sling to the connector straps.
- You can attach the shoulder sling to the handstrap slots/shoulder sling connector straps on either side of the device, according to your preference.
- You can attach a shoulder sling to the top or bottom handstrap slots, or use two shoulder slings and attach them crosswise to the device to create a harness.

Using the desktop hub

An optional accessory, the Ranger 7 data collector desktop hub connects to the device with a USB cable. It provides:

- One display port, which supports a single 2K monitor (up to 2560 x 1600 x 30 fps)
- One DVI-I and one HDMI port, which support dual monitors (up to 2048 x 1152 x 60 fps)

- One Gigabit Ethernet port for wired access at ultra-fast speeds
- Three USB 3.0 SuperSpeed ports for the latest peripherals
- One USB 3.0 powered port for fast device charging
- One Audio In/Out port for microphones, speakers, and earphones
- An integrated lock slot which accommodates security locks to safeguard equipment

To use external monitors, drivers are required; the Ranger 7 data collector downloads the drivers when it is first connected to the desktop hub (this may take a few minutes). Once the drivers are downloaded, the Ranger 7 data collector will use the drivers every time the hub is connected.

Using the cameras

- ▶ Taking photos and videos
- ▶ Changing camera settings
- ▶ Enable the Camera app to access your location to geo-tag photos
- ▶ Viewing photos and videos

The Ranger 7 data collector is fitted with two cameras; a 2MP camera on the front of the device, and an 8MP camera with LED flash on the rear. Both cameras are accessible by the camera application.

NOTE – The device may be shipped with a protective film covering the rear camera and flash windows. Remove the film with a fingernail or the plastic stylus tip before first use to ensure proper focus and exposure of your photos and videos.



Taking photos and videos

By default, the built-in Camera app is ready to take photos, but you can switch easily between photo and video mode. Before you use the camera, make sure you have removed the protective film on the camera and flash window:

To take a photo or record a video:

1. Tap  / **Camera**. By default, the front camera launches.
If you want to switch to the rear camera, tap the icon in the top left of the screen.
2. The main Camera or Video icon on the center right of the screen shows what mode the camera is in: Photo or Video. To switch from one mode to the other, tap the small Camera or Video icon above the main icon.
3. To take a picture or start recording video, tap the main icon when in the desired mode.

Changing camera settings

1. Tap  / **Camera** to launch the Camera app.
2. To access the camera settings, tap  in the top right corner of the screen.
3. To hide the Camera settings, tap elsewhere on the screen.

Enable the Camera app to access your location to geo-tag photos

1. In the Camera app settings, under **Related settings**, tap **Choose whether camera can use location info**.
2. Tap **Yes** to confirm you want to switch apps.
3. Make sure **Location** is selected, then slide the **Location service** switch to **On**.
4. Close the **Settings** app to return to the **Camera** app.

Viewing photos and videos

By default, your photos and videos are saved to the **Camera roll** on the Ranger 7 data collector

There are several ways to look through your photos and videos:

- **Camera app**: tap the thumbnail in the bottom right corner of the screen to open the **Photos app** and then do any of the following:
 - select **See all photos**
 - swipe right or left to scroll through other photos / videos in your collection.
- **Photos app**: open the **Photos app** from the Windows Start menu.
- **File Explorer or OneDrive app**: Go to your **Pictures library** and open your **Camera roll**.

Using the pre-installed apps

- ▶ [Trimble EMPOWER Hub](#)
- ▶ [Bundled Microsoft apps](#)
- ▶ [Getting more apps](#)

The Ranger 7 data collector comes with a range of useful pre-installed software.

Trimble EMPOWER Hub

Control and manage Trimble EMPOWER modules from one convenient, easy-to-use application. For more information, refer to the module documentation available here: www.trimble.com/empowermodules.

Bundled Microsoft apps

Here are some of the useful productivity applications that come bundled with your Ranger 7 data collector powered by the Windows 10 Pro operating system.

OneNote. Use the OneNote app on your device to take notes and store them in the cloud. For more info, see www.onenote.com.

- **Mail.** Mail automatically organizes your inbox. You can add multiple accounts and access them through this single point.
- **Calendar.** Use Calendar to manage your schedule.
- **People.** The People app brings all your contacts together in a single space. See each contact's email address, phone number, website, and other information at a glance.
- **Microsoft Edge.** Microsoft Edge gives you fast and fluid access to the Internet. Open pages in Reading View, save them to your reading list, or take notes right on the page using inking. Check out Get to know Microsoft Edge on Windows.com for details.
- **Camera.** The Camera app lets you take regular photos, photo bursts, or video using either the front or back camera on the device.

- **Photos.** Edit and organize your photos using the Photos app. Crop, enhance, and add effects to your images.
- **News.** News brings you the latest breaking stories as well as more in-depth coverage. You can customize the coverage to add more local information or highlight the topics you choose.
- **Weather.** The Weather app offers hourly, daily, and 10-day forecasts as well as historical information and annual weather trends.

Getting more apps

You can install more apps and programs from the Windows Store, websites, or a CD or DVD. To learn more see [How to install programs on Windows 10](https://support.microsoft.com) on <https://support.microsoft.com>.

To find applications for your Ranger 7 data collector, go to Microsoft Store on www.microsoftstore.com.

Troubleshooting, downloading updates, and repair

- ▶ [Troubleshooting](#)
- ▶ [Operating system and software updates](#)
- ▶ [Repairing your device](#)

Troubleshooting

This section contains answers to some common troubleshooting questions. If you encounter problems when using your Ranger 7 data collector, try the following troubleshooting tips to detect and solve the problem. If problems persist, contact your local distributor for support.

Further assistance and support with the Windows 10 Pro operating system

For comprehensive online support, how-to guides, troubleshooting articles and related downloads for the Windows 10 Pro operating system, go to the online Microsoft support pages for the Windows 10 operating system.

Performance issues

Device is running slowly

- Operating system updates may be installing.

Windows 10 Pro may have automatically downloaded software or operating system updates, and is installing these in the background. While these updates are being

installed, system performance may be reduced, or wireless connectivity speed may appear to be slower than normal.

- You may have too many background applications are running.
Some programs start automatically and run in the background. You can disable these programs at startup to improve Windows startup time and overall system performance.
- You may have malware or a virus.
A virus or other malicious software could cause your device to run slowly. Check whether your device has a virus by using Windows Defender, which is included with Windows 10, or refer to the documentation for your third party antivirus software.
- Check your wireless network speed.
If the apps you are using are connecting to the Internet, a poor network connection may be causing them to run slowly. For detailed information on checking your network, see [Wi-Fi speed is slow, page 73](#).
- Check for low disk space.
You may be able to improve performance if you free up some disk space on your device. Disk Cleanup can delete temporary and system files, empty the Recycle bin, and remove apps and data that you no longer need.
- Your device may have overheated.
If you are using your device in a hot environment and/or are using a processor or memory-intensive, your device may have become too hot. Move your device to a cooler spot, wait five minutes, and see if it runs faster.

EMPOWER module issues

My field software doesn't recognize my EMPOWER module

- Check module contacts and attachment
It is possible the contacts between the module and the device are dirty, or that the module is not attached correctly. Ensure that the module contacts are clean and that the screws are tightened correctly.
- Your field software is not configured to communicate with the EMPOWER module
Check that your field software supports the EMPOWER module directly and that the field software is configured to talk to the EMPOWER module directly or through the correct COM port.

Refer to the Trimble EMPOWER modules documentation here www.trimble.com/empowermodules for more information.

Wireless connectivity issues

Wi-Fi speed is slow

- Your network is running slow for all devices.

You should first check to see whether your network is slow on another device. Can you connect to your wireless network and browse the web at normal speeds from another device? Try running a Network Speed Test to ensure your Internet connection is functioning normally.

- Your Wi-Fi signal is weak.

Look at the wireless network Wireless network icon icon in the taskbar.

This icon  shows your current signal strength. If the icon is partially dimmed, move your device closer to your wireless router to see if the signal improves. If your router is broadcasting on both a 2.4GHz and 5GHz frequency, try connecting to a different frequency. In general, a network operating on the 5GHz frequency will be faster and less susceptible to interference, but will have a shorter range than a 2.4GHz network.

Power and battery issues

Battery will not charge

- The battery is overheated, or too cold.

The battery will charge between 0 °C and 40 °C (32 °F and 104 °F). If you have been using or storing the battery and/or device in a particularly hot or cold environment, the battery may be outside the safe charging temperature range. Sensors in the battery will prevent the battery from charging until its temperature returns to a normal level.

- The battery is not installed correctly.

If the battery is not installed correctly in the device or the battery charger, it may not have a proper connection and will not charge.

- The battery terminals are dirty or corroded.

If the terminals of the battery are dirty or corroded, it may not have a proper connection and will not charge.

Device will not start up

- The batteries do not have enough charge to power the device:
Press and hold the charge indicator button on each of the batteries. At least one charge LED must be lit up to indicate that a battery has enough power for the device to start on battery power. If no LEDs light up on a battery, attach the device to an external power source, or swap the batteries for charged batteries, then try again.
- The batteries is not correctly installed.
The device may not be receiving power from the batteries if they are not installed properly. Remove both the batteries, then replace them correctly.

Device suddenly turned off during use

- The device may have run out of power and gone into critical suspend mode.
If your battery charge level gets too low, the device will automatically go into a hibernate mode to prevent loss of data. Check the battery level by pressing and holding the battery level button on each of the batteries. If the battery charge is too low, connect the device to external power, or swap the batteries for a charged batteries.

If you regularly run out of battery power while in the field, consider carrying spare batteries with you. The device supports hot-swapping of the batteries. Swap one battery at a time; you must always have one battery with sufficient charge in the device while you remove a battery and replace it with another. If you remove both batteries, the device shuts down.

Restarting or resetting the operating system

If your device becomes unresponsive, and the troubleshooting guide does not resolve the problem, you need to restart or reset your device.

For detailed instructions on the recovery options in Windows 10, refer to the Microsoft support pages on Windows 10 recovery options at www.support.microsoft.com.

Restarting your (unresponsive) device

If your device is no longer responding to touchscreen or keypad input, you may need to force it to restart by removing power from the system.

NOTE – *Restarting the system by holding down the Power key removes power to the CPU. Any unsaved files and settings will be lost.*

To force your device to restart, press and hold the Power key until the device shuts down (~15 seconds), then restart your device by pressing the Power key.

Resetting your device

If restarting your device does not resolve the issue that you are seeing, resetting it might help. Resetting lets you choose to keep your files or remove them, and then reinstalls the operating system.

To reset your device:

1. Tap  / **Settings** / **Update & security** / **Recovery**.
2. Select **Get started** then follow the onscreen instructions to reset your device.
3. At the reset menu, select one of the following:
 - **Keep my files.**
 - Reinstalls Windows 10 and keeps your personal files.
 - Removes apps and drivers you installed.
 - Removes changes you made to settings.
 - Removes any apps your dealer or distributor installed.
 - **Remove everything.**
 - Reinstalls Windows 10 and removes all your personal files.
 - Removes apps and drivers you installed.
 - Removes changes you made to settings.
 - If you're planning to donate, recycle, or sell your device, use this option and choose to fully clean the drive. This might take an hour or two, but it makes it harder for other people to recover files you have removed.

Operating system and software updates

Periodically, operating system and software application updates will be available for your device.

Windows 10 updates

The Windows 10 operating system periodically checks for updates so you don't have to. When an update is available, it is automatically downloaded and installed — keeping your device up-to-date with the latest features.

Installing the latest updates can help fix common issues, but you must be online to download the updates. If you are having trouble connecting and downloading updates because your wireless network is too slow, you can try using a wired network via the Desktop Hub accessory.

Once online, to check for and install the latest updates manually, go to **Settings / Update & security / Windows Update**, and select **Check for updates**. If **Windows Update** says your device is up to date, you have all the updates that are currently available.

Spectra Precision recommends that you keep the Windows operating system updated. This reduces your vulnerability to cyber attacks, and helps to improve the Windows operating system. You can configure the settings to prevent downloads and restarts in field; go to **Settings / Update & Security / Windows Update / Update Settings**.

For more information about Windows updates, refer to the official *Windows Update: FAQ* on www.microsoft.com.

Software downloads and updates

The latest versions of software including drivers, firmware updates, and software utilities, are available on the [technical support pages](#) on www.trimble.com.

Repairing your device

Before you send your Ranger 7 data collector for repair, check the troubleshooting guide in this document. If you can't solve the problem with troubleshooting, contact your local Spectra Precision dealer for further support.

Repair of this product should only be performed by an authorised service provider. Any attempt to disassemble this product by a non-authorised service provider will void the warranty.

For more information, contact your local Spectra Precision dealer.